

SimMechanics™

Visualization and Import Guide

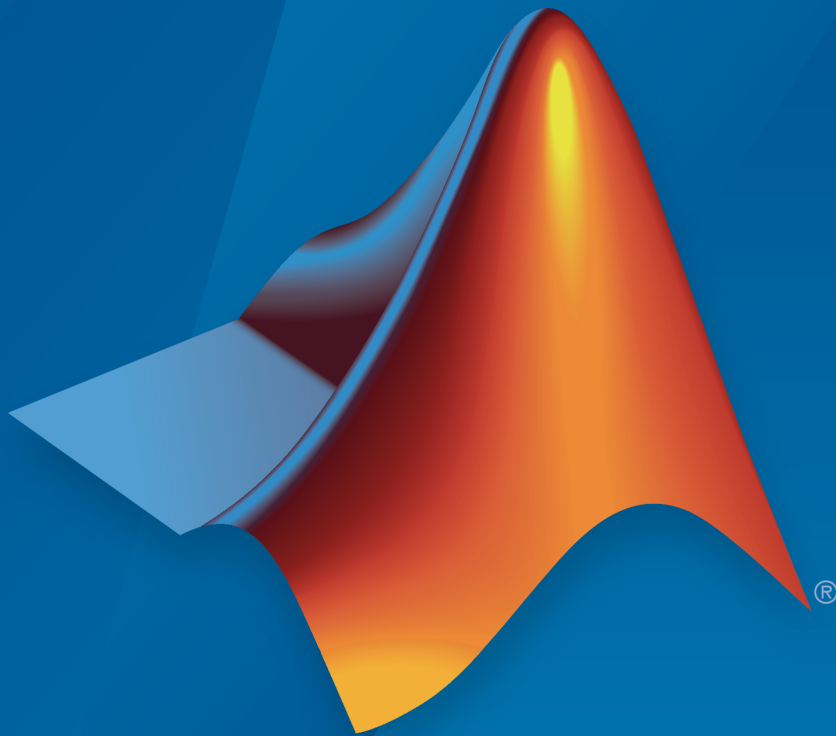

MATLAB® & SIMULINK®

R2011b

 MathWorks®

How to Contact MathWorks



Latest news: www.mathworks.com
Sales and services: www.mathworks.com/sales_and_services
User community: www.mathworks.com/matlabcentral
Technical support: www.mathworks.com/support/contact_us



Phone: 508-647-7000



The MathWorks, Inc.
3 Apple Hill Drive
Natick, MA 01760-2098

SimMechanics™ Visualization and Import Guide

© COPYRIGHT 2001–2012 by The MathWorks, Inc.

The software described in this document is furnished under a license agreement. The software may be used or copied only under the terms of the license agreement. No part of this manual may be photocopied or reproduced in any form without prior written consent from The MathWorks, Inc.

FEDERAL ACQUISITION: This provision applies to all acquisitions of the Program and Documentation by, for, or through the federal government of the United States. By accepting delivery of the Program or Documentation, the government hereby agrees that this software or documentation qualifies as commercial computer software or commercial computer software documentation as such terms are used or defined in FAR 12.212, DFARS Part 227.72, and DFARS 252.227-7014. Accordingly, the terms and conditions of this Agreement and only those rights specified in this Agreement, shall pertain to and govern the use, modification, reproduction, release, performance, display, and disclosure of the Program and Documentation by the federal government (or other entity acquiring for or through the federal government) and shall supersede any conflicting contractual terms or conditions. If this License fails to meet the government's needs or is inconsistent in any respect with federal procurement law, the government agrees to return the Program and Documentation, unused, to The MathWorks, Inc.

Trademarks

MATLAB and Simulink are registered trademarks of The MathWorks, Inc. See www.mathworks.com/trademarks for a list of additional trademarks. Other product or brand names may be trademarks or registered trademarks of their respective holders.

Patents

MathWorks products are protected by one or more U.S. patents. Please see www.mathworks.com/patents for more information.

Revision History

October 2008	Online only	New for Version 3.0 (Release 2008b)
March 2009	Online only	Revised for Version 3.1 (Release 2009a)
September 2009	Online only	Revised for Version 3.1.1 (Release 2009b)
March 2010	Online only	Revised for Version 3.2 (Release 2010a)
September 2010	Online only	Revised for Version 3.2.1 (Release 2010b)
April 2011	Online only	Revised for Version 3.2.2 (Release 2011a)
September 2011	Online only	Revised for Version 3.2.3 (Release 2011b)

1 | Introducing Visualization and Animation

About SimMechanics Visualization	1-2
Starting Visualization	1-2
Using Visualization	1-3
About Body Color and Geometry	1-5
About Body Color: Default and Custom	1-5
About Body Geometry: Default, Standard, and Custom	1-5
Standard Body Geometry: Equivalent Ellipsoids	1-5
Standard Body Geometry: Convex Hulls	1-8
Custom Body Geometry and External Graphics Files	1-10
Hierarchy of Body, Machine, and Model Visualization	
Settings	1-11
Visualized Geometries and Colors from Body Block Settings	1-11
Body Block Settings Affecting Body Visualization	1-12
Visualization Settings in the Machine and Model Hierarchy	1-13

2 | Getting Started with the Visualization Window

Introducing the SimMechanics Visualization Window	2-2
About the Visualization Window	2-2
Opening and Updating the Visualization Window	2-2
Visualization Toolbar and Its Controls	2-4
Controlling Body and Body Component Display	2-6
About Body and Body Component Display	2-6
Interpreting the Body Display Symbols and Shapes	2-6
Changing Body Display Symbols	2-7

Changing Body Display Shapes	2-7
Adjusting the Camera View	2-9
Setting the Background Color	2-9
Interpreting the Camera Projection, Field of View, and Viewpoint	2-9
Automatically Sizing the Camera Field of View	2-11
Automatically Setting a Camera Viewpoint	2-12
Actively Controlling the Camera Viewpoint	2-13
Camera Viewpoint and Mouse Controls	2-14
 Communicating with the Model from the Visualization	
Window	2-16
Highlighting Bodies, Body Components, and Body Blocks ..	2-16
Updating the Model Diagram	2-17
Saving Visualization Settings to the Model	2-18
 Controlling Simulation from the Visualization Window ...	2-20
Starting, Pausing, and Stopping the Simulation	2-20
Timing the Simulation	2-20
 Controlling Animation	2-22
About Animation	2-22
How Animation Works	2-22
Automatically Adapting the Camera View to the Displayed Motion	2-23
Changing How the Animation Is Updated	2-24
Speeding Up the Animation in Real Time	2-25
 Recording Animation	2-27
About Recording	2-27
How Recording Works	2-27
Recording Animations	2-27
Compressing Animation Recordings	2-29
Controlling the Size of the Recorded Animation	2-30
Playing Recordings of Animation	2-30
 SimMechanics Visualization Menus and Their Controls ...	2-32
About the Visualization Window Menus	2-32
View Menu	2-33
Simulation Menu	2-34
Model Menu	2-36
Help Menu	2-37

Customizing Visualization and Animation

3

About Custom SimMechanics Visualization	3-2
Customizing Visualization Settings	3-2
Creating an External Virtual Reality Client	3-3
Customizing Visualized Body Colors	3-4
Choosing Custom Body Colors	3-4
Switching Between Default and Custom Body Colors	3-4
Customizing Visualized Body Geometries	3-7
Choosing Custom Body Geometries	3-7
Switching Between Standard Body Geometries	3-7
About STL Body Graphics Files	3-8
Obtaining STL Body Graphics Files for Custom Body Geometries	3-9
Switching Between Standard and Custom Body Geometries	3-10
Visualizing with a Virtual Reality Client	3-12
About Virtual Worlds for Machines and Models	3-12
Creating Virtual Worlds for SimMechanics Models	3-12
Interfacing SimMechanics Models with Virtual Worlds	3-14
Creating and Interfacing a Model Virtual World	3-16
Reference	3-26

Importing Mechanical Models

4

Mechanical Import	4-2
About Mechanical Import and CAD Translation	4-2
Requirements for CAD Export and Mechanical Import	4-3
Essential CAD Translation Steps	4-4
Generating New Models from Physical Modeling XML	4-6
About Generated SimMechanics Models Based on CAD	4-6
Generating a New Model from a Physical Modeling XML File	4-6

Controlling New Model Import	4-8
Working with Generated Models	4-11
About CAD-Based Models	4-11
Common Features of CAD-Based Models	4-11
Nondefault Features in Generated Models	4-14
Manually Modifying and Extending Generated Models After Import	4-15
Model Update with Physical Modeling XML	4-20
About Model Update and Mechanical Import	4-20
Updating a Machine in a Generated Model with Revisions .	4-23
Adding a New Machine to a Generated Model	4-25
Replacing Generated Model or Subsystem Contents with a New Machine	4-27
Controlling Model Update at the Block Level	4-29
Associativity and Updating	4-29
Working with Associativity in Common Updating Situations	4-31
Controlling How Update-Import Changes Individual Blocks and Connections	4-34
Associativity in an Updating Sequence Example	4-37
Troubleshooting Imported and Updated Models	4-41
Best Practices for Creating and Exporting Assemblies	4-41
Inserting Reference Coordinate Systems into Assemblies Before Export	4-41
Controlling Mechanical Import to Assist Troubleshooting .	4-42
Troubleshooting Errors During Model Generation	4-42
Troubleshooting Errors During Model Update	4-43
Troubleshooting Model Simulation Errors	4-43
Troubleshooting SimMechanics and Simulink Problems ...	4-43
Import a CAD Rigid Body	4-45
Import Robot Arm Model	4-46
Import SimMechanics XML File	4-46
Modify Imported Model	4-47
Remove Redundant Rigid Bodies	4-47
Add Actuator and Sensor Blocks	4-47
Configure Tolerances	4-48
Simulate and Visualize Robot Arm Motion	4-49

Import a CAD Stewart Platform Model	4-50
Review Generated Model and Count DoFs	4-50
Delete Unnecessary Bodies and Joints	4-52
Add Actuators and Sensors	4-53
Visualize Stewart Platform Motion	4-53

Computer-Aided Design Translation

5

Case Study Overview	5-2
Requirements	5-2
Terminology	5-2
Export a CAD Rigid Body	5-4
Access the Example Files	5-4
Examine Rigid Body Parameters	5-4
Export CAD Rigid Body	5-6
Import CAD Rigid Body	5-6
Translate CAD Constraints into SimMechanics Joints	5-7
Access the Example Files	5-8
Translation of Two-Part Models	5-8
Block Structure of Two-Part Models	5-9
Translate Assembly with Six-DoF Joint	5-10
Translate Assembly with Prismatic Joint	5-11
Translate Assembly with Revolute Joint	5-14
Translate Assembly with Rectangular Joint	5-15
Translate Assembly with Spherical-Spherical Massless Connector	5-16
Export and Re-Export a Pendulum Assembly	5-19
About Model Update	5-19
CAD Assembly Files	5-19
Translate CAD Assembly	5-20
Modify Pendulum Assembly and Update SimMechanics Model	5-24
Add New Body to Create a Triple Pendulum	5-30
Update Imported Model While Retaining Manual Joint Replacements	5-35
Selectively Update Imported Model	5-36

Export CAD Robot Arm	5-38
CAD Robot Arm Files	5-38
CAD Robot Arm Properties	5-38
Export Robot Arm Assembly	5-40
Import Model	5-40
Export a CAD Stewart Platform	5-41
About the Stewart Platform	5-41
CAD Assembly	5-41
Open Assembly	5-42
Export Assembly	5-43
Import Model	5-43

Introducing Visualization and Animation

You can visualize your model's bodies using the SimMechanics visualization window. This overview explains the essentials of starting visualization and choosing body colors and geometries.

- “About SimMechanics Visualization” on page 1-2
- “About Body Color and Geometry” on page 1-5
- “Hierarchy of Body, Machine, and Model Visualization Settings” on page 1-11

About SimMechanics Visualization

In this section...

“Starting Visualization” on page 1-2

“Using Visualization” on page 1-3

Starting Visualization

Starting SimMechanics visualization requires two choices, one for your entire model, the second for each in your model. These choices are part of configuring your model for simulation, as discussed in “Starting Visualization and Simulation”. Implement your visualization choices at any time by clicking **Apply** or **OK**.

Enabling Visualization for an Entire Model

You enter the visualization settings for an entire model in the **Visualization** area of the **SimMechanics** node of the Configuration Parameters dialog. To open visualization, you must select at least one of these check boxes.

Model-wide visualization is turned off by default.

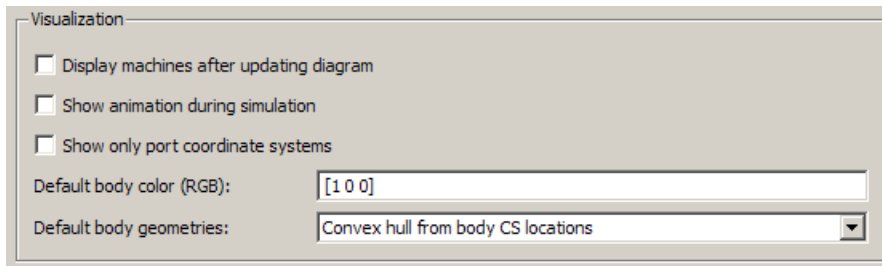

To start visualization, you must select at least one of the first two check boxes:

- **Display machines after updating diagram** for static visualization
- **Show animation during simulation** for dynamic animation

Select the **Show only port coordinate systems** check box if you want to visualize only those Body coordinate systems with visible ports on their respective Body blocks in the

model. The default is unselected, so that all Body coordinate systems are visualized on their respective bodies.

Visualizing All Bodies in a Machine

You can choose whether or not to visualize a specific machine in your model through the **Visualization** tab of its Machine Environment block dialog. A single window displays all selected machines in a model.

By default, each machine is selected for visualization. If you turn off machine visualization, your choice only affects that machine, not the entire model.

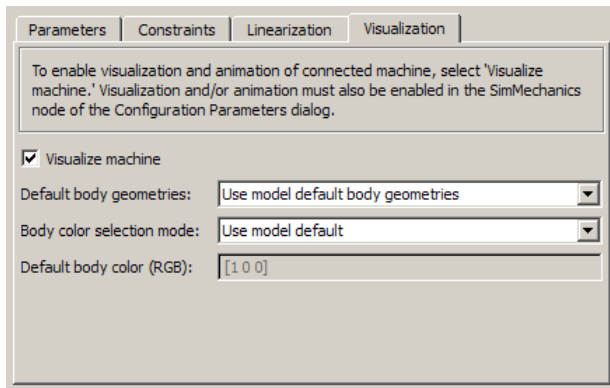

Other SimMechanics Visualization Controls

All other visualization controls are located on the SimMechanics visualization window itself. You can access them once the window is open.

You control custom visualization choices for individual bodies in their respective Body dialogs.

Using Visualization

You can visualize a model using a static display or a dynamic animation.

Display Versus Animation

SimMechanics visualization serves two distinct purposes, static and dynamic. In both cases, you can change your observer viewpoint and navigate through the scene, as well as change the visualized body properties.

Static Display

You can display a static state of your model at different stages of modeling. Use static display in the initial state, during construction. Either:

- Open the visualization before or while you build your model. You display each body as you add it to your model, if you also update the block diagram.

Having the visualization window open during model building lets you keep track of your model's bodies and how they are connected. You can see unphysical or mistaken constructions before you finish the model.

- Open the visualization after you finish the model. All the bodies in the model appear together.

Also use static display after a simulation ends, or after you pause or stop it. In these cases, the visualization window shows the model at later times or in the final state.

Dynamic Animation

You can also display an animation of body motion while the SimMechanics model is running. Use this feature to watch the model's dynamics in three dimensions and visualize motions and relationships more easily than is possible with Scope blocks alone.

About Body Color and Geometry

In this section...

“About Body Color: Default and Custom” on page 1-5

“About Body Geometry: Default, Standard, and Custom” on page 1-5

“Standard Body Geometry: Equivalent Ellipsoids” on page 1-5

“Standard Body Geometry: Convex Hulls” on page 1-8

“Custom Body Geometry and External Graphics Files” on page 1-10

About Body Color: Default and Custom

The initial default color of all visualized bodies is red. You can modify this default or replace it by custom colors for individual bodies, one at a time. For more information, see “Creating an External Virtual Reality Client”.

About Body Geometry: Default, Standard, and Custom

You can choose how the visualization window displays the bodies in size and shape (geometry). There are two available *standard* geometries:

- Equivalent ellipsoid for each body, based on its mass properties and center of gravity (CG) position
- Convex hull for each body, based on its Body coordinate systems (CSs)

The convex hull geometry is the initial default body geometry for all visualized bodies.

Standard Body Geometry: Equivalent Ellipsoids

The inertia tensor \mathbf{I} of a rigid body is real and symmetric, so it has three real eigenvalues (I_1, I_2, I_3) and three orthogonal eigenvectors. These eigenvectors are the principal axes of the body. In the coordinate system defined by those axes, the inertia tensor is diagonal. The *trace* of the inertia tensor, $\text{Tr}(\mathbf{I}) = I_1 + I_2 + I_3$, is the same in any coordinate system with its origin at the body's center of gravity (CG).

Every rigid body has a unique equivalent ellipsoid, a homogeneous solid ellipsoid of the same inertia tensor. In Cartesian coordinates, the ellipsoid surface is given by

$$\left(\frac{x}{a_x}\right)^2 + \left(\frac{y}{a_y}\right)^2 + \left(\frac{z}{a_z}\right)^2 = 1$$

where m is the body's mass. The three parameters (a_x , a_y , a_z) are the *generalized radii* of the ellipsoid. For axis $i = 1,2,3$,

$$a_i = \sqrt{5[\text{Tr}(\mathbf{I}) - 2I_i]/(2m)}$$

Triangle Inequalities

The *principal moments* (I_1 , I_2 , I_3) must satisfy the *triangle inequalities*:

$$I_2 + I_3 \geq I_1$$

$$I_3 + I_1 \geq I_2$$

$$I_1 + I_2 \geq I_3$$

Violation of the triangle inequality for I_i leads to an unphysical imaginary generalized radius a_i .

Caution Visualizing the equivalent ellipsoid of a body whose principal moments do not satisfy the triangle inequalities leads to a SimMechanics warning indicating that one or more triangle inequalities have been violated. The simulation continues, but the body in violation is not displayed.

Ellipsoids with Special Symmetry

In general, all three I_i , $i = 1,2,3$, are unequal. Such a body is an *asymmetric top*. If two of the three I_i are equal (double degeneracy), the body is a *symmetric top*. The third axis is the axis of symmetry. If all three I_i are equal (triple degeneracy), the body is a *spherical top* and dynamically equivalent to a homogeneous sphere.

Reduced-Dimension Ellipsoids

In special cases, the equivalent ellipsoid reduces to a planar, linear, or point figure.

Let (i,j,k) label the three axes $(1,2,3) = (x,y,z)$ in any order.

- For a true *ellipsoid*, with nonzero volume, all the α_i are nonzero. The triangle inequalities are strict inequalities in this case:

$$I_j + I_k > I_i$$

$$I_k + I_i > I_j$$

$$I_i + I_j > I_k$$

- For an *ellipse*, with zero volume but nonzero area, one $\alpha_i = 0$ and the other two α_j, α_k are nonzero. One of the triangle inequalities becomes an equality:

$$I_j + I_k = I_i$$

$$I_k + I_i > I_j$$

$$I_i + I_j > I_k$$

- For a *line*, with zero volume and area but nonzero length, two $\alpha_i, \alpha_j = 0$ and the third α_k is nonzero. Two of the triangle inequalities become equalities:

$$I_j + I_k = I_i$$

$$I_k + I_i = I_j$$

$$I_i + I_j > I_k$$

Equivalently, $I_i = I_j$ are nonzero and $I_k = 0$.

- For a *point*, with no spatial size, all three α_i vanish. All three triangle inequalities become equalities:

$$I_j + I_k = I_i$$

$$I_k + I_i = I_j$$

$$I_i + I_j = I_k$$

Equivalently, all three I_i vanish.

Visualizing the Simple Pendulum Rod with Equivalent Ellipsoids

Consider the simple pendulum rod in “Visualize a Simple Machine” in the SimMechanics Getting Started guide. You can open the model by entering `mech_spen` at the command line.

The rod length $L = 1$ m, and its radius $r = 1$ cm. The inertia tensor is

$$\begin{pmatrix} I_{xx} & 0 & 0 \\ 0 & I_{yy} & 0 \\ 0 & 0 & I_{zz} \end{pmatrix} = \begin{pmatrix} mr^2/2 & 0 & 0 \\ 0 & mL^2/12 & 0 \\ 0 & 0 & mL^2/12 \end{pmatrix}$$

Because the rod has an axis of symmetry, the x -axis in this case, two of its three principal moments are equal: $I_{yy} = I_{zz}$, and two of its three generalized radii are equal: $a_y = a_z$. The rod is a symmetric top and, since r is much smaller than L , its equivalent ellipsoid is almost a line of zero volume and area.

The generalized radii of the equivalent ellipsoid are $a_x = \sqrt{5/3} (L/2) = 0.646$ m and $a_y = a_z = \sqrt{5} (r/2) = 1.12$ cm. This is the rod so displayed:

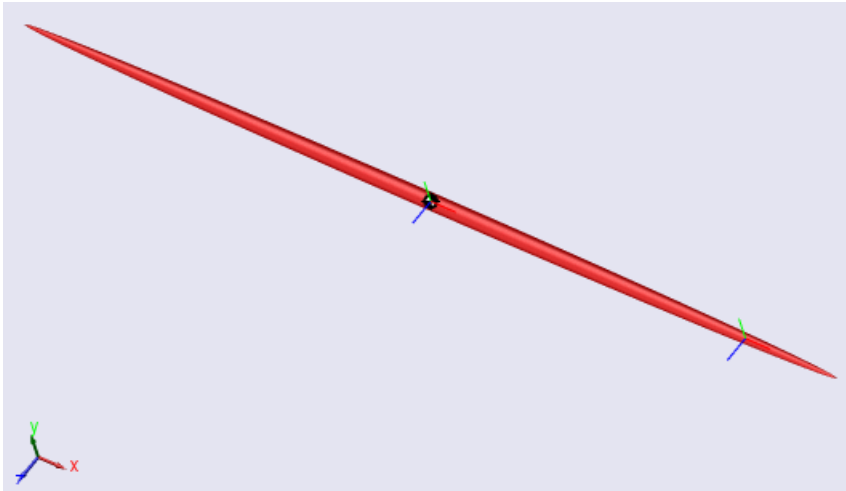

Standard Body Geometry: Convex Hulls

Every Body has at least one Body coordinate system (CS) at the CG. A Body also has one or more extra Body CSs for the attached Joints, as well as possible Actuators and

Sensors. Each Body CS has an origin point, and the collection of all these points, in general, defines a volume in space. The minimum outward-bending surface enclosing such a volume is the convex hull of the Body CSs, and this is the alternative standard body geometry. The SimMechanics convex hull excludes the CG CS.

To enclose a nonzero volume, this set must have at least four non-coplanar Body CSs. Three non-collinear Body CSs are displayed instead by a triangle, and two non-coincident origins are displayed by a line. One origin is displayed just as a point.

Four or more coplanar origins are displayed as a triangle, three or more collinear origins are displayed as a line, and two or more coincident origins are displayed as a point.

Visualizing the Four-Cylinder Engine Crank with Convex Hulls

Open the four-cylinder engine model by entering `mech_fceng` at the command line. Start visualization.

Open the Engine Block subsystem and note the Crank block representing the engine crank. This Body block has five coplanar Body CSs, not including the CG CS. Visualize the engine as convex hulls and click the Crank body, the largest body. The convex hull forms a planar polygon.

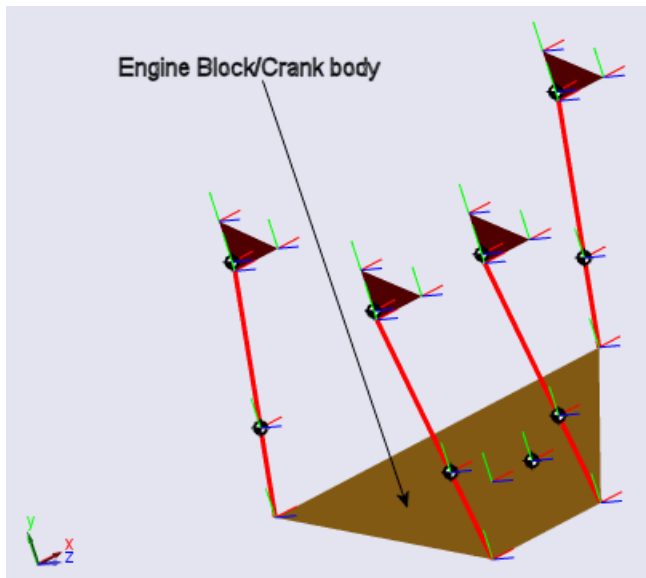

Custom Body Geometry and External Graphics Files

In place of the standard body geometry choices, you can provide a custom geometry defined with external graphics files for one or more individual bodies. For more information, see “Customizing Visualized Body Geometries”.

Hierarchy of Body, Machine, and Model Visualization Settings

In this section...
“Visualized Geometries and Colors from Body Block Settings” on page 1-11
“Body Block Settings Affecting Body Visualization” on page 1-12
“Visualization Settings in the Machine and Model Hierarchy” on page 1-13

Visualized Geometries and Colors from Body Block Settings

The SimMechanics visualization window visualizes bodies represented by Body blocks in your model. The visualization information that the window uses from the model comes strictly from the mass, coordinate system, and visualization properties set individually in each Body block's dialog.

Note: The window itself contains additional visualization controls that affect visualized body geometries and colors.

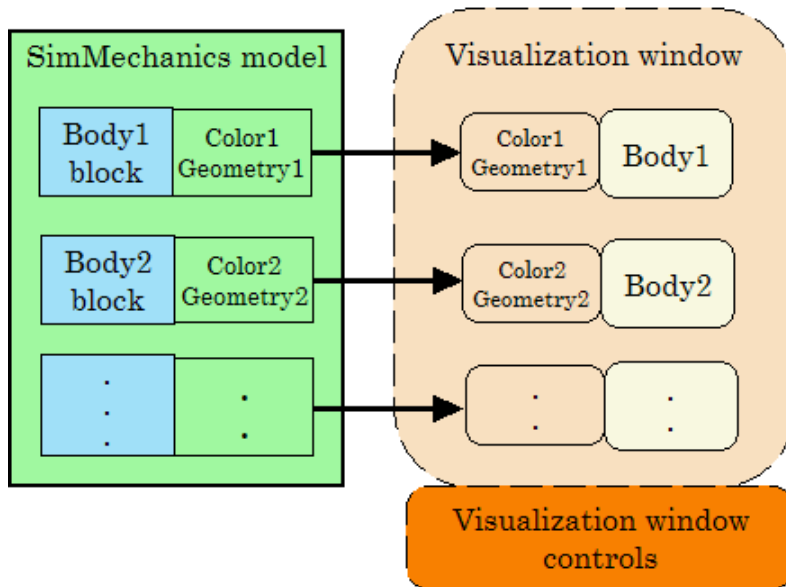

Body Block and Visualization Window Settings Control Body Visualization

Body Block Settings Affecting Body Visualization

How settings in Body block dialogs affect visualization depends on which type of body geometry and which color you choose for a particular body. The Body dialog contains three classes of such choices.

Mass Properties

The principal inertial moments and the mass of a body determine the size and shape of its equivalent ellipsoid.

Body Coordinate Systems: Origins and Orientation

The relative positions of the Body's coordinate systems (CSs) determine the size and shape of its convex hull.

Visualization

The color choice in the Body dialog's **Visualization** tab determines the color of the visualized body.

You make the choice of convex hull or equivalent ellipsoid to visualize an individual body in the Body dialog's **Visualization** tab.

If you choose a custom body geometry for a Body, the external body geometry file referenced in the Body dialog's **Visualization** tab determines the visualized body's size and shape.

Note: The choice of standard or custom body geometry has no effect on the visualized body's color. The choice of body color has no effect on the visualized body's geometry.

Visualization Settings in the Machine and Model Hierarchy

SimMechanics models start with *initial default* visualization settings. A model and machines within the model also possess, respectively, *model-wide* and *machine-wide default* visualization settings. Visualization settings are inherited from the highest level (model) through machines to individual Bodies. You can change these default and inherited settings.

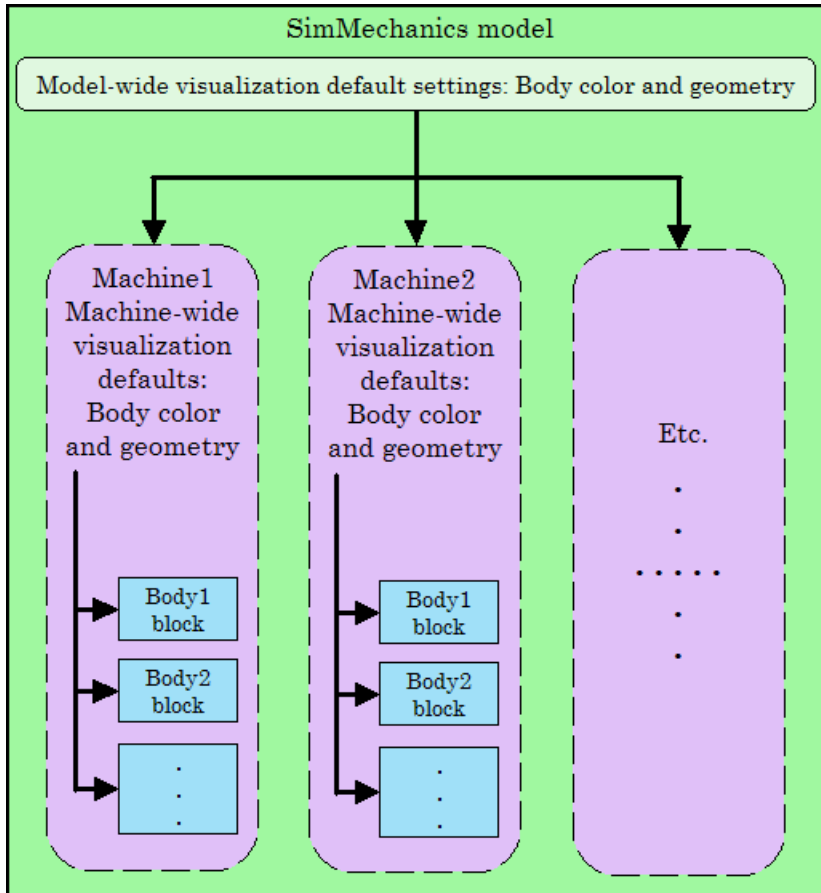

Inheritance Hierarchy of Default Visualization Settings

Initial Default Settings for a Model

The initial default visualization settings for an entire model are:

- Model-wide default body color: red (RGB value of $[1 \ 0 \ 0]$)
- Model-wide default body geometry: convex hull

Machine Inheritance of Model-Wide Default Settings

The initial default visualization settings for a machine are:

- Machine-wide default body color: inherit model-wide default
- Machine-wide default body geometry: inherit model-wide default

Body Inheritance of Machine-Wide Default Settings

The initial default visualization settings for a Body are:

- Default Body color: inherit machine-wide default
- Default Body geometry: inherit machine-wide default

Getting Started with the Visualization Window

The SimMechanics visualization window allows you to control how you view your model's bodies in both static display and dynamic simulation-based animation. It also allows you to record animations.

- “Introducing the SimMechanics Visualization Window” on page 2-2
- “Controlling Body and Body Component Display” on page 2-6
- “Adjusting the Camera View” on page 2-9
- “Communicating with the Model from the Visualization Window” on page 2-16
- “Controlling Simulation from the Visualization Window” on page 2-20
- “Controlling Animation” on page 2-22
- “Recording Animation” on page 2-27
- “SimMechanics Visualization Menus and Their Controls” on page 2-32

Introducing the SimMechanics Visualization Window

In this section...

“About the Visualization Window” on page 2-2

“Opening and Updating the Visualization Window” on page 2-2

“Visualization Toolbar and Its Controls” on page 2-4

About the Visualization Window

The visualization window is an integral part of SimMechanics software. With it, you can visualize your machines using a comprehensive set of display controls, interact with your model, and watch and record animations.

The window uses a distinctive set of symbols and shapes to display bodies and Body coordinate systems (CSs). This section is an overview of what you can do with the SimMechanics window.

Caution The SimMechanics visualization window resembles a MATLAB[®] Graphics figure window. But it is not a feature of MATLAB and has no figure handle.

Opening and Updating the Visualization Window

Starting visualization and choosing the default display options are discussed in “About SimMechanics Visualization”.

- Once you configure your SimMechanics model for visualization, select **Update Diagram** from the model's **Edit** menu (or press **Ctrl+D**).

The window opens and displays the machines in your model that you have chosen to visualize. One window displays all selected machines simultaneously.

- To synchronize the static visualization display with your model, reselect **Update Diagram** at any time.

This figure shows a model with the default background color.

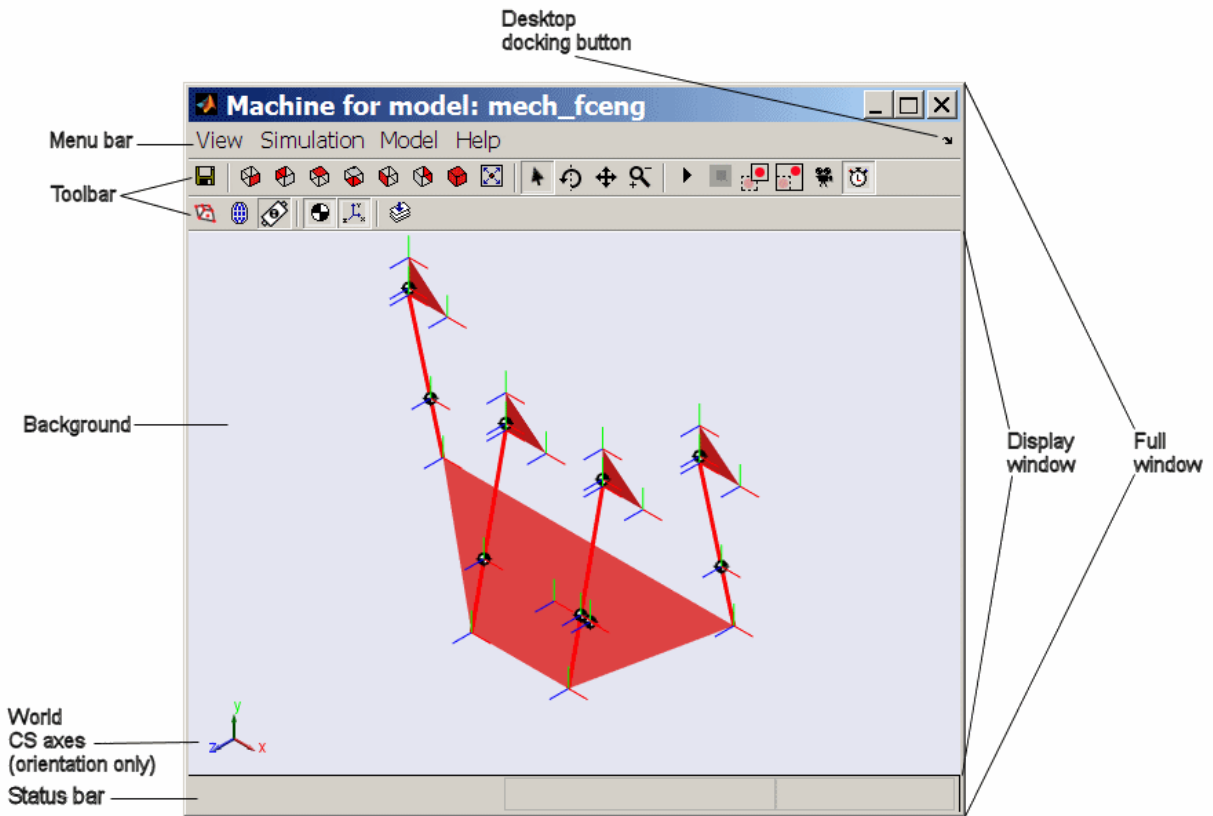

SimMechanics Visualization Window Displaying a Four-Cylinder Engine (Isometric View)

Menu Bar Versus Toolbar Controls

Once you open the visualization window, you have two ways to control the display and carry out these tasks:

- Use the buttons in the toolbar. Every feature on this toolbar occurs in the menus, although the reverse is not true. See “Visualization Toolbar and Its Controls”.
- Use the menus in the menu bar. The menu contains specialized items and submenus. See “SimMechanics Visualization Menus and Their Controls”.

Note: Changing the display settings using the visualization window controls changes only your immediate view in the display window. By itself, it does not change the visualization settings in the model.

If you want to save a change in the visualization window settings to the model, and thus change the model's visualization settings, see “Communicating with the Model from the Visualization Window”.

Visualization Toolbar and Its Controls

You can activate or change most visualization features by selecting buttons on the window toolbar, instead of selecting items from the menus. The setting changes initiated by the toolbar are the same as the corresponding menu actions: either you activate a feature, enable or disable a feature, or initiate an immediate action.

Hovering your mouse cursor over a toolbar button displays the button's tooltip indicating its function.

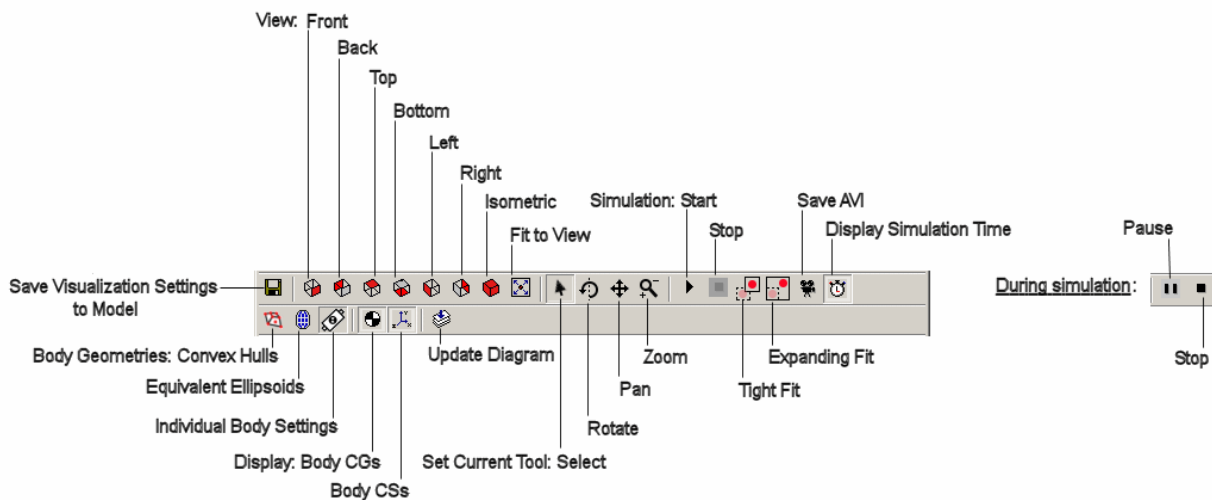

SimMechanics Toolbar Buttons

Toolbar Relationship to the Menus

You can access all of the toolbar functions in the menus as an alternative. The toolbar reproduces most of the menu functions.

See “SimMechanics Visualization Menus and Their Controls” for a complete overview of the visualization window controls.

Controlling Body and Body Component Display

In this section...

“About Body and Body Component Display” on page 2-6

“Interpreting the Body Display Symbols and Shapes” on page 2-6

“Changing Body Display Symbols” on page 2-7

“Changing Body Display Shapes” on page 2-7

About Body and Body Component Display

You can change how bodies look in the SimMechanics visualization window. This section explains how to control body and body component display.

Interpreting the Body Display Symbols and Shapes

When a visualization window opens, it uses distinctive conventions to display the bodies of your model.

Body Component Display

Body components are displayed with two distinctive symbols:

- The center of gravity (CG) point of each body is marked by a half-filled circle-plus symbol .
- Each Body coordinate system (CS) is marked by coordinate axis triads. The color coding is X-Y-Z axes = RGB = red-green-blue.



Body Surface Display

The window displays all the bodies of every machine with visualization enabled. The entire body surface is shaded with the color you choose for it. Its shape is one of these:

- Convex hull: a line, one or more joined surface patches, or a closed surface enclosing a volume
- Equivalent ellipsoid
- A custom shape

Changing Body Display Symbols

You can turn off the CS triads, the CG symbols, or both using the toolbar, with the **Display Centers of Gravity** and **Display Coordinate Systems** buttons.

You can activate or deactivate each button separately. The default for both is active.

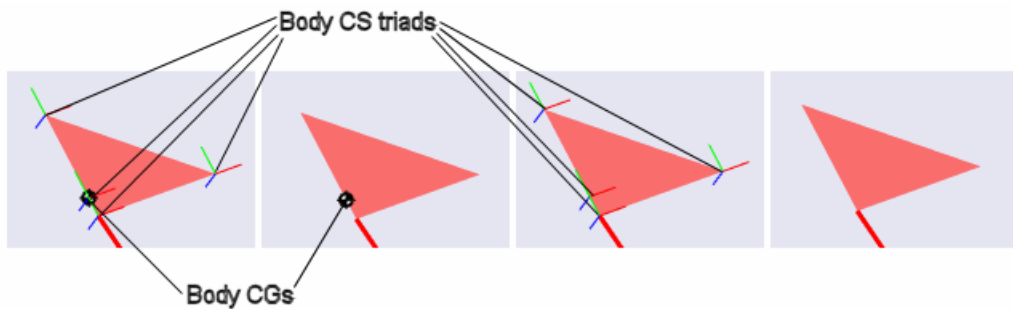

Four-Cylinder Engine: Cylinder Piston With and Without Body CS Triads and CGs (Detail)

Changing Body Display Shapes

You can switch among three possible display shape options using the toolbar. They are mutually exclusive; one is always active.

- Clicking the **Set Body Geometries to Convex Hulls** button displays all bodies as convex hulls, regardless of the visualization settings in the Body blocks in the model.
- Clicking the **Set Body Geometries to Ellipsoids** button displays all bodies as convex hulls, regardless of the visualization settings in the Body blocks in the model.
- Clicking the **Set Body Geometries to Individual Body Settings** button displays each body according to the visualization settings in its Body block in the model. This is the default.

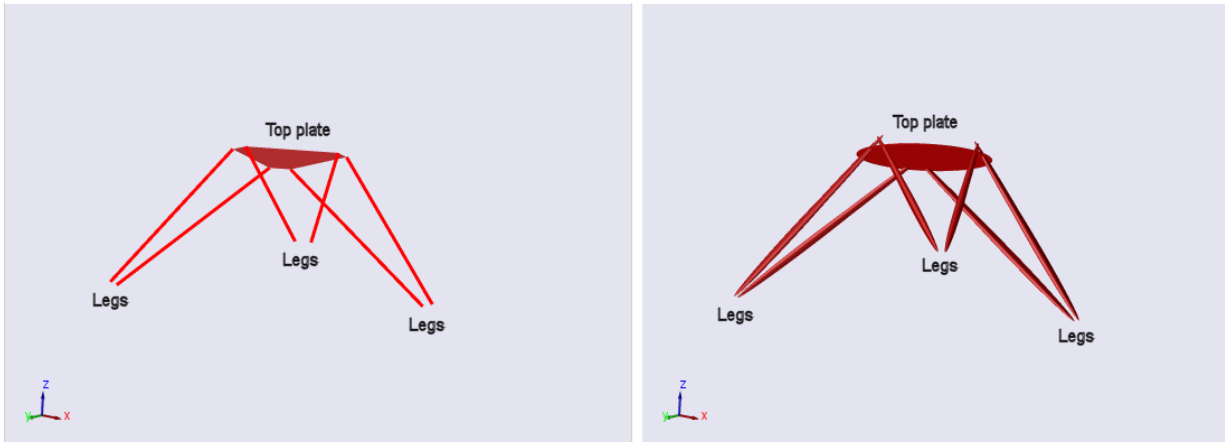

Stewart Platform: Bodies Displayed as Convex Hulls and as Equivalent Ellipsoids

Adjusting the Camera View

In this section...

“Setting the Background Color” on page 2-9

“Interpreting the Camera Projection, Field of View, and Viewpoint” on page 2-9

“Automatically Sizing the Camera Field of View” on page 2-11

“Automatically Setting a Camera Viewpoint” on page 2-12

“Actively Controlling the Camera Viewpoint” on page 2-13

“Camera Viewpoint and Mouse Controls” on page 2-14

Setting the Background Color

You must use the menu bar to change the background color of the display window within the SimMechanics visualization window.

- 1 Open **View**, then select **Change Background Color**. A color palette opens.
- 2 Select a color. Click **OK** to implement your choice. The background color changes immediately.

The color palette for the background is the same as the palette for custom body color. See “Customizing Visualized Body Colors”.

Interpreting the Camera Projection, Field of View, and Viewpoint

To properly interpret what you see in visualization, imagine that the display window shows the field of view of a camera. The properties of this virtual camera determine most of what you need to know about controlling your view of the model's machines.

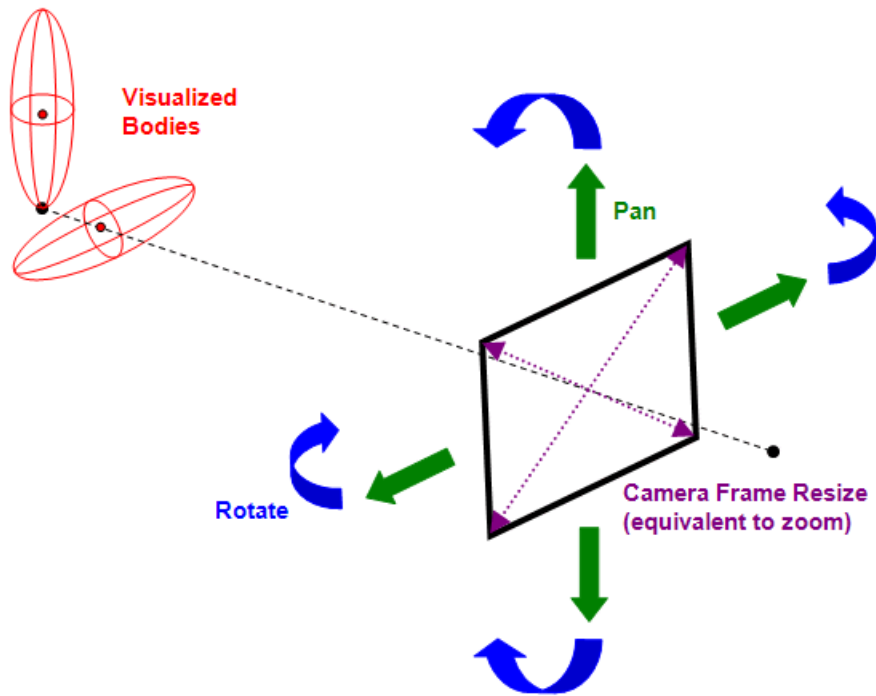

Visualization Window Camera Field and Visualized Scene

Visualization and Orthographic Projection

The visualization window uses *orthographic* (parallel) projection to reduce a three-dimensional scene to two dimensions on your screen. That is, parallel lines of view representing depth converge to a point only at infinity. The window displays the scene without finite perspective.

Camera Field of View, Viewpoint, and Frame Size

The *field of view* is what you see within the virtual camera frame. The virtual camera's *viewpoint* is the point and direction from which it views the scene. The virtual camera frame has a size or *aperture*.

Zooming

Changing the camera frame size or aperture, then shrinking or expanding the overall size of the machines, is the equivalent of *zooming* in or out. The camera cannot zoom directly, because there is no point of convergence or perspective.

Panning

Panning changes the camera's virtual location without changing its direction of view. It means moving the camera frame horizontally or vertically in a constant virtual plane, maintaining the orientation of the camera frame.

Rotating

Rotating means viewing the scene from a different direction, while maintaining a constant zoom (effective distance from the machines).

A rotation rotates about the center of the geometric bounding box containing all the objects in the field of view. (This geometric center is unrelated to body properties, such as Body coordinate systems or centers of gravity.) The viewpoint is moved to another point on the virtual sphere with this same geometric center. The view direction changes to maintain the geometric center at the center of the display window.

World Coordinate System Axes Indicate Orientation Only

The World CS axis triad always appears at the lower-left corner of the display window.

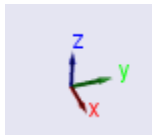

The directions of the axes indicate orientation only. The position of the axes does not, in general, indicate the position of the World coordinate system (CS) origin.

Automatically Sizing the Camera Field of View

You can automatically resize the camera's field or aperture size to fit all the visualized objects. This step is equivalent to an automatic zoom. It does not rotate the viewpoint or pan the camera.

To fit the field of view to size, click the **Fit to View** button on the toolbar. The camera field resizes itself immediately.

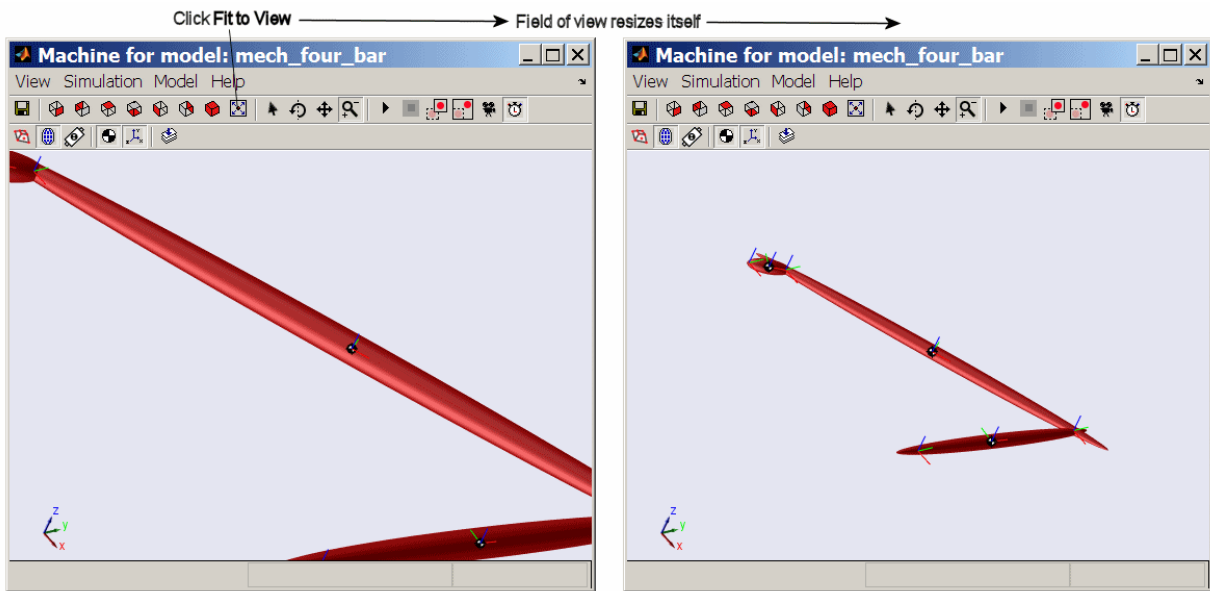

Automatically Setting a Camera Viewpoint

You can automatically change your viewpoint of the visualized bodies by clicking one of the six viewpoint buttons on the toolbar. The action applies immediately.

Clicking these buttons is equivalent to setting a plane of view defined by the World CS axes. Except for the isometric view, these predefined viewpoints always have one axis perpendicular to the plane of view (pointing into or out of the plane of view). The isometric view is a viewpoint direction with equal direction cosines (all $1/\sqrt{3}$).

The default is the front view, with X pointing right, Y pointing up, and Z pointing out of the plane of view.

Toolbar Button	Axes and Orientation of View Plane
Front View (default)	X points right – Y points up
Back View	X points left – Y points up
Top View	X points right – Z points down
Bottom View	X points right – Z points up

Toolbar Button	Axes and Orientation of View Plane
Left View	Z points right – Y points up
Right View	Z points left – Y points up
Isometric View	X points down and right – Y points up – Z points down and left

Actively Controlling the Camera Viewpoint

The four selection-viewpoint toolbar control buttons enable certain interactions between your mouse and the display window through point-and-click or point-click-hold-and-roll.

These four toolbar-menu controls are mutually exclusive; you can activate at most one of them at a time. The default is for the Select Tool to be active.

- Enable a tool by clicking on its button.
- Disable all of them by clicking the currently active tool button.

Function	Tool	How to Use
Select bodies	Select (default)	Point with the mouse at a visualized body, then click on any mouse button.
Viewpoint controls	Rotate	Point with the mouse anywhere in display window. Then left-click, holding the mouse button, and roll mouse.
	Pan	
	Zoom	

Results of Rolling the Mouse with the Viewpoint Controls

With one of the three viewpoint control tools enabled, rolling the mouse produces one of three possible results in the display window.

Rotate Tool

Rolling so that the arrow moves in the display window along a line, rotates the view about that line. Rolling in a more complex figure rotates the view in a more complex way.

Pan Tool

Rolling forward, back, left, or right pans up, down, left, or right, respectively.

Zoom Tool

Rolling forward or back zooms out or in, respectively. You zoom toward or away from the point that you initially clicked on. Rolling left or right does nothing.

For More About the Select Tool

See “Highlighting Bodies, Body Components, and Body Blocks”.

Camera Viewpoint and Mouse Controls

The four selection-viewpoint tool controls and the computer mouse have a complementary relationship to each other.

Normal Versus Dynamic Mouse Control

In *normal mouse control*, the left mouse button's function corresponds to the function activated in the menus or toolbar. Depending on which function you activate from the menu or toolbar, you can switch the left mouse button from normal to dynamic mouse control and back. “Actively Controlling the Camera Viewpoint” explains this case.

In *dynamic mouse control*, the viewpoint controls are disabled from the menu or toolbar. (Either the Select Tool is enabled, or all four selection-viewpoint controls are disabled from the menu or toolbar.) You can still exercise the viewpoint controls with the three mouse buttons, which are mapped one-to-one to the viewpoint controls.

Note: If your mouse has fewer than three buttons, you cannot access the dynamic mouse control functions associated with the missing button or buttons.

Normal and Dynamic Mouse Control with Left Mouse Button

The left mouse button's mapping is more complex.

Viewpoint Control	Active	How to Use
Normal: Pan	If Pan Tool is enabled from menu or toolbar	Pan field of view by clicking and holding anywhere in display window and rolling mouse.

Viewpoint Control	Active	How to Use	
Normal: Zoom	If Zoom Tool is enabled from menu or toolbar	Zoom field of view by clicking and holding anywhere in display window and rolling mouse.	
Dynamic: Rotate	If Pan and Zoom Tools are disabled from menu or toolbar	If Select Tool is disabled from menu or toolbar:	Rotate viewpoint by clicking and holding anywhere in display window and rolling mouse.
		If Select Tool is enabled from menu or toolbar:	Rotate viewpoint by clicking and holding on only background in display window and rolling mouse. Clicking on a visualized body in this case selects the body and has no effect on viewpoint.

Dynamic Mouse Control with Center and Right Mouse Buttons

The center and right mouse buttons' mappings are always dynamic.

Mouse Button	Viewpoint Control	Active	How to Use
Center	Dynamic: Pan	If Select Tool is disabled from menu or toolbar:	Pan field of view by clicking and holding anywhere in display window and rolling mouse.
		If Select Tool is enabled from menu or toolbar:	Pan field of view by clicking and holding on only background in display window and rolling mouse. Clicking on a visualized body in this case selects the body and has no effect on field of view.
Right	Dynamic: Zoom	If Select Tool is disabled from menu or toolbar:	Zoom field of view by clicking and holding anywhere in display window and rolling mouse.
		If Select Tool is enabled from menu or toolbar:	Zoom field of view by clicking and holding on only background in display window and rolling mouse. Clicking on a visualized body in this case selects the body and has no effect on field of view.

Communicating with the Model from the Visualization Window

In this section...
“Highlighting Bodies, Body Components, and Body Blocks” on page 2-16
“Updating the Model Diagram” on page 2-17
“Saving Visualization Settings to the Model” on page 2-18

Highlighting Bodies, Body Components, and Body Blocks

If you have the Select Tool enabled, clicking a body, Body coordinate system (CS), or Body center of gravity (CG) in the SimMechanics visualization window causes the following:

- The displayed body or body component changes color:
 - A selected body surface or CS triad becomes yellow.
 - A selected CG changes from white-black to yellow-black.
- The visualization window displays the associated Body block or Body CS name and its path at the lower left just below the display window, in the status bar.
- The associated Body block is outlined in red in the model window.

To unhighlight, click the highlighted body again. You can select and highlight a body both in static display and during simulation.

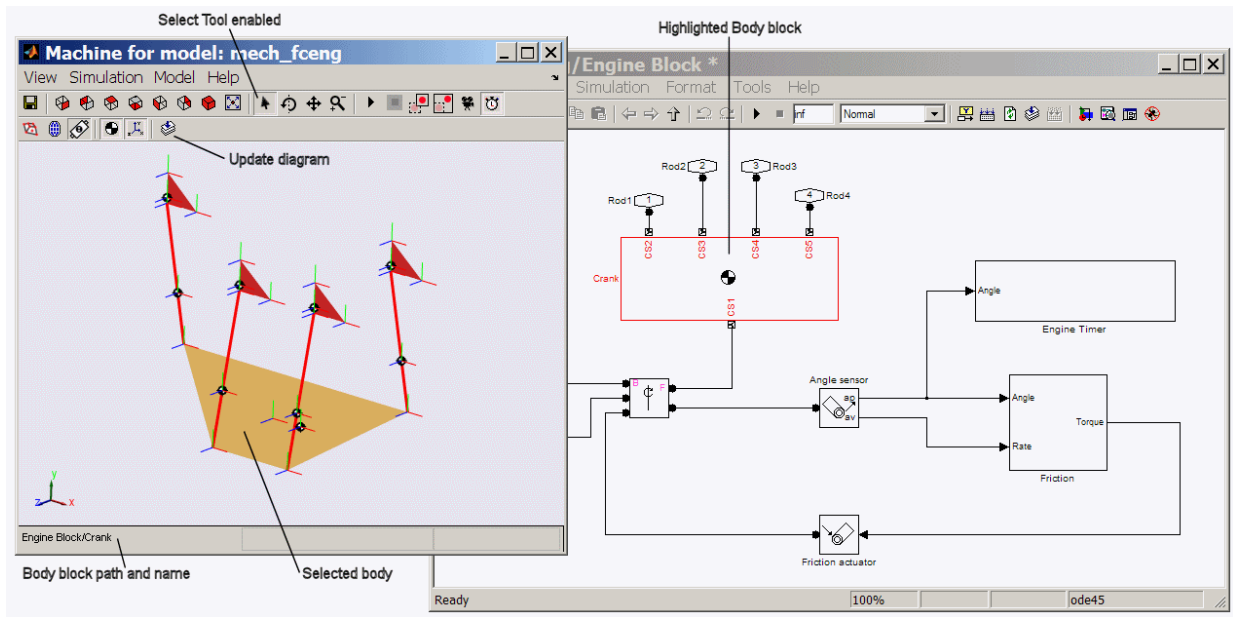

SimMechanics Visualization Window with Highlighted Body and Body Block (Four-Cylinder Engine)

Enabling and Disabling Highlighting

You can enable or disable the highlighting of model Body blocks from the **Model** menu item **Enable Model Highlighting**. The default is enabled.

Whether model highlighting is enabled or disabled, clicking a body or body component in the window always highlights it. If you disable model highlighting, the associated Body block is not highlighted when you click the displayed body or body component.

Updating the Model Diagram

You can update your Simulink model diagram from the model toolbar or **Edit** menu, or by pressing **Ctrl+D** from the keyboard.

You can also update it by clicking the **Update Simulink Diagram** button in the visualization window toolbar.

Saving Visualization Settings to the Model

As you work with the visualization settings, you might want to save the setting changes that you make.

- Changes you make to the visualization settings apply only to the display while the window is open. If you do nothing else and close the window, then upon reopening the visualization window, the display will revert to whatever model requires for visualization settings. See “Hierarchy of Body, Machine, and Model Visualization Settings”.
- If you want to save the display setting changes you made from the window controls before closing the window, you must save them to the model. Click the **Save Visualization Settings to Model** button on the visualization window toolbar. A warning dialog appears, asking if you want to save the model itself.
- If you want to save these display setting changes before closing the model, you must save or resave the model itself. Click the **Save** button in the model toolbar.

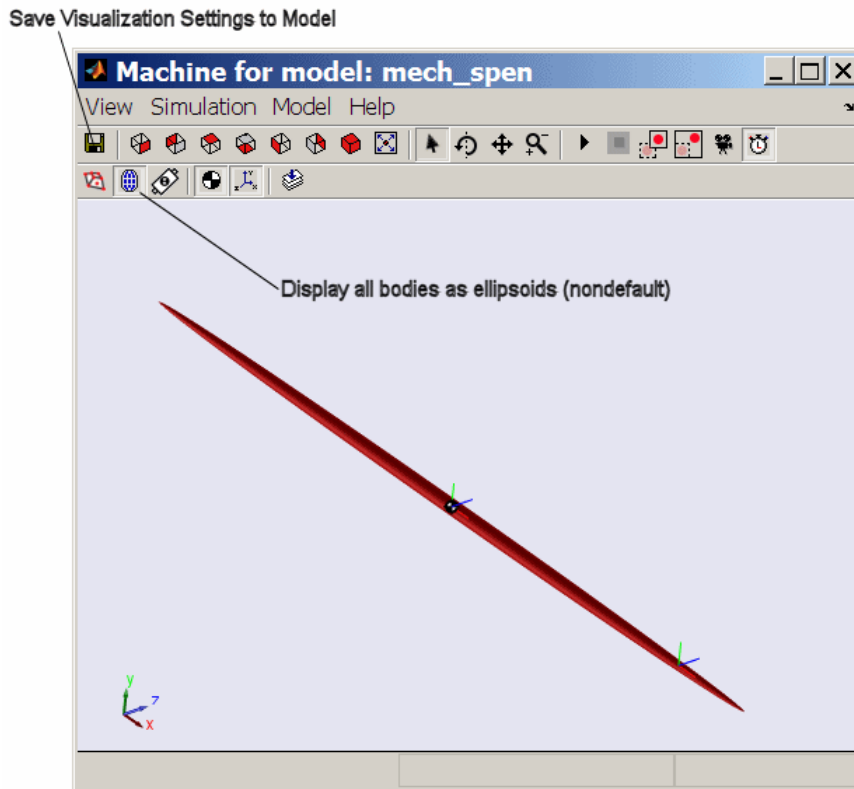

Caution If the changes to the display settings include changing the displayed body geometries, the saved visualization settings will make the visualization window display whatever the setting requires (all convex hulls, all equivalent ellipsoids, or individual body geometries). But the saved visualization display settings do not change the visualization settings at the model, machine, or Body block level in the model.

Controlling Simulation from the Visualization Window

In this section...

“Starting, Pausing, and Stopping the Simulation” on page 2-20

“Timing the Simulation” on page 2-20

Starting, Pausing, and Stopping the Simulation

You can control a simulation from the SimMechanics visualization window with the pair of simulation control buttons. The pair takes two different appearances, depending on whether the simulation is running.

With Simulation Stopped

From left to right, the buttons are **Start** and **Stop**, with **Stop** disabled: .

With Simulation Running

From left to right, the buttons are **Pause** and **Stop**: .

- If you pause a running simulation, restarting it begins the simulation at the simulated time when it was stopped.
- If you stop a running simulation, restarting it begins the simulation at a simulated time of zero.

Timing the Simulation

Once you start the simulation, you can track the simulation time at the lower right of the visualization window, in the status bar, if the simulation time display is active.

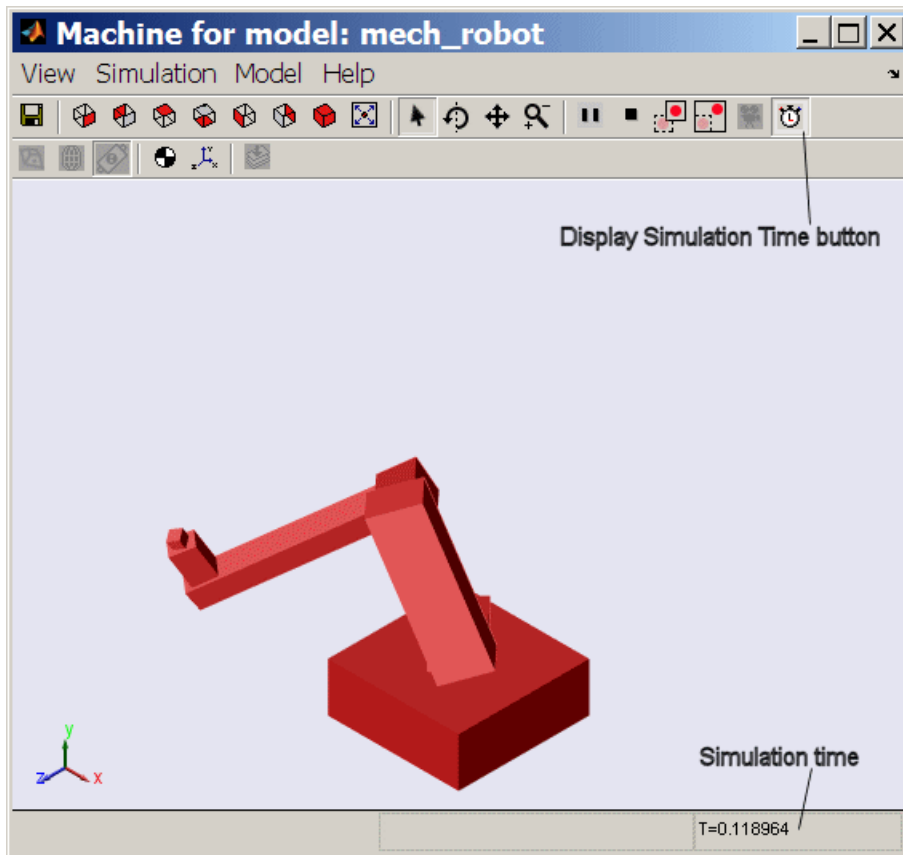

Simulation Time Display (Robot Arm Simulation with Visualized Body CSs and CGs Deactivated)

Activating and Deactivating the Simulation Time Display

You can activate or deactivate the simulation time display using the **Display Simulation Time** button on the toolbar. The default is active.

Controlling Animation

In this section...

“About Animation” on page 2-22

“How Animation Works” on page 2-22

“Automatically Adapting the Camera View to the Displayed Motion” on page 2-23

“Changing How the Animation Is Updated” on page 2-24

“Speeding Up the Animation in Real Time” on page 2-25

About Animation

When you start a simulation with visualization and animation enabled, the SimMechanics visualization window displays the body motion. This section shows how you can control the animation.

How Animation Works

The visualization window displays the animated bodies in whatever camera view you previously set before starting simulation. By default, the camera remains at rest in World.

The animation that you see in the display window is the result of three distinct processes operating in parallel.

- Simulink[®] updates the model simulation at every *simulation time step*.
- Simulink updates the model outputs at every *output sample time step*.
- During animation, the visualization window updates the display of the bodies at every *visualization sample time step*.

Each updated, displayed simulation scene is also called a *frame*.

By default, the output sample times are every major time step, and the visualization sample times are the output sample times. But, within limits, you can change the relationships among these time steps.

Caution Because visualization needs the model outputs to update the animation, the visualization sample time should be equal to or longer than the model output sample

time. If the visualization sample time is shorter, the displayed animation is updated at the model output sample times.

Automatically Adapting the Camera View to the Displayed Motion

As the bodies move in the animation, the camera view you set for the static case before simulation might not encompass their full range of motion. Or the bodies might move out of the field of view altogether.

You can require the display window to adapt the field of view dynamically to the animation with the **Enable Automatic Expanding Fit** and **Enable Automatic Tight Fit** buttons on the toolbar. These buttons are mutually exclusive. The default for both is disabled.

Allowing the Field of View to Expand with the Moving Bodies

If the animated bodies tend to move out of the field of view once, repeatedly, or continually, click the **Enable Automatic Expanding Fit** button. The field of view will then expand as necessary to encompass the geometric bounding box of all the bodies, as visualized. The camera remains at rest in World.

Keeping the Field of View Limited to the Moving Bodies

If you want your field of view to encompass just the moving bodies and track them as they move, click the **Enable Automatic Tight Fit** button. The center of the field of view will remain fixed to the center of the geometric bounding box of all the bodies, as visualized. The camera is no longer at rest in World, but continually zooms and pans to track this geometric center.

Caution With automatic tight fit enabled, the observer's reference frame is no longer at rest in World and, in general, is noninertial. The motion of bodies that you see is not that seen by an observer in World.

This automatic tight fit can create the illusion that the bodies as a whole are not moving. Disable the automatic tight fit to check if this is the case.

Changing How the Animation Is Updated

You might find it convenient to change how quickly the animation in the display window responds to changes in the simulation, especially if the animation is going by too fast in real (clock) time.

You can change most of these controls by going to the **Simulation** menu in the menu bar, then to **Control Animation Speed**. The Animation Speed Control Parameters dialog box opens. You can apply any changes and close the dialog by clicking **OK**.

Delaying the Simulation at Every Display Update

At each update of the animation display, the SimMechanics simulation is delayed for some (simulated) time to allow you to follow the motion. You can change this delay time in the Animation Speed Control Parameters dialog. Enter a nonnegative time (in milliseconds) in the **Delay per frame** field. The default is **3 (ms)**.

Changing the Visualization Sample Time

You can break the default connection between visualization and model output sample times in the Animation Speed Control Parameters dialog as well. Enter a specified visualization sample time (in seconds) in the **Visualization sample time** field. This time is simulated (not real) time.

The default is 0 (s). This is smaller than any positive model output sample time, and the visualization is effectively updated at the output sample times.

Require the visualization explicitly to inherit the model output sample time by entering -1.

Changing the Model Output Sample Time

You can also change the effective visualization sampling rate by changing the model output sample time in the model's Configuration Parameters dialog and leaving the visualization sample time to be whatever the model output sample time is. This time is simulated (not real) time.

- 1 Open the Configuration Parameters dialog from the **Simulation** menu of your model window.
- 2 On the **Data Import/Export** node, in the **Save options** area, change the **Output options** pull-down menu entry to **Produce specified output only**.

- 3 Use the **Output times** field on the right to specify explicitly how often Simulink should capture the simulation output. In this field, enter a vector of sample times. The sample time range must be the same as or lie within the **Start time** and **Stop time** range of the **Simulation time** area in the **Solver** node of Configuration Parameters.

If you want a uniform output sampling, use the `linspace` command to specify the time range and number of sample points:

```
linspace(start-time, end-time, number-of-points)
```

For example, to sample 200 points from 0 to 10 seconds:

- 1 Open Configuration Parameters from the **Simulation** menu.
- 2 Locate **Output options** in the **Data Import/Export** node. Change the pull-down menu to **Produce specified output only**.
- 3 Enter `linspace(0,10,200)` in the **Output times** field. Click **Apply** or **OK**.

Tip This approach does change two distinct model features at once. Changing the visualization sample time by itself (preceding) has the advantage of letting you specify the model output sample time separately.

See the Simulink documentation for more about model output sample time.

Speeding Up the Animation in Real Time

As the simulation animates the bodies' motions, it might slow down. You can make the animation computationally less demanding with these measures.

Skipping Frames

By default, the animation displays every updated frame. But you can skip a fixed number of frames between displayed frames.

From the **Simulation** menu, select **Control Animation Speed**. In the Animation Speed Control Parameters dialog, change the **Number of skipped frames per update** field to a positive integer to specify this number. The default is 0.

Using fewer sample points leads to a more disjointed animation, but a faster simulation and a smaller recorded animation file.

Turning Off Visualization Features

You can speed up the animation if you turn off one or both of these symbols:

- Body centers of gravity (CGs)
- Body coordinate systems (CSs)

The preceding section, “Controlling Body and Body Component Display”, explains how to control their display.

You can also speed up the animation by turning off the simulation time display. See the preceding section, “Controlling Simulation from the Visualization Window”.

Recording Animation

In this section...

“About Recording” on page 2-27

“How Recording Works” on page 2-27

“Recording Animations” on page 2-27

“Compressing Animation Recordings” on page 2-29

“Controlling the Size of the Recorded Animation” on page 2-30

“Playing Recordings of Animation” on page 2-30

About Recording

As the SimMechanics visualization window displays the body motion, you can capture what you see as a recording and save it. This section explains how to record animations. See the preceding section, “Controlling Animation”, for more about animation.

How Recording Works

If you record an animation, the recording captures each updated, displayed simulation scene as a *frame*.

Whatever you see in the animated display window, is what the recording captures, as closely as it can within the limitations of the format.

Recording Animations

When you record an animation from the window, it is stored as a file on your system in Audio Video Interleave (AVI) format.

Caution Recording an animation overwrites any existing file with the same name as the AVI file in the same folder. The AVI file write fails if a file of the same name that is locked by another application exists in the same folder.

Activating and Controlling Animation Recording

- You can activate animation recording by clicking the **Store Animation in AVI File** button on the toolbar. The default is deactivated.

If you activate, the AVI File Location file browser opens, as discussed next.

- You control recording settings using the **Simulation** menu.

Specifying the Name and folder of the Animation File

You can specify a location and name for your AVI file recording by selecting **Choose AVI File Location** from the **Simulation** menu. If you activate recording, an AVI File Location file browser opens and requires you to select a location and specify an AVI name. The default AVI name for a model called `modelname.mdl` is `modelname.avi`, but you can change this default name. Click **Save** to complete the AVI file specification.

When you activate recording, this AVI file name appears in the bottom middle of the full visualization window, below the display, in the status bar.

If you cancel the file browser, the recording is canceled as well.

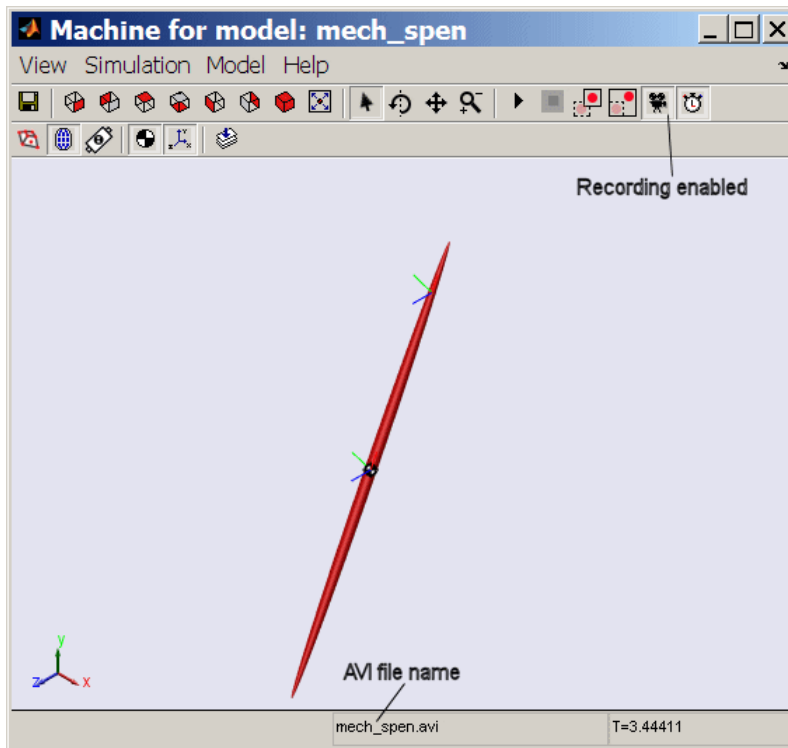

How MATLAB Records the Animation

The simulation first records a MATLAB movie by capturing the display at every visualization sample time step. Then, in the termination phase of your simulation, it converts this movie to AVI format and stores it in the AVI file. A small AVI Conversion window opens to indicate that conversion and storage are complete and to display the path of the AVI file. Click **OK** to close this prompt.

Compressing Animation Recordings

You can reduce the size of your AVI file by compressing it. Select **Compress AVI File** to activate this feature. The default is active.

Support Restrictions for Recording Compression

AVI compression is available only on the Windows® platform. MATLAB uses the Indeo 5 compression algorithm. You must have the corresponding video codec installed to

- Compress an animation while recording.
- Decompress and play back a compressed animation recording.

Check your operating system configuration for installed video codecs.

Caution You must have the Indeo 5 video codec installed to compress an animation recording. If you do not have this codec installed, animation and recording proceed, but with compression deactivated.

Controlling the Size of the Recorded Animation

Any technique that reduces the number of visualization samplings and updates reduces the total stream of animated frames and the size of the recorded file. See “Controlling Animation”.

Tip If MATLAB runs out of memory while recording an animation, you will receive a warning. The simulation continues until completion, but recording is truncated at the simulation time when memory was exhausted.

Use one of the techniques discussed to reduce the total stream of animated frames and attempt the recording again. The simplest technique is to skip frames.

Playing Recordings of Animation

You need an AVI-compatible video player to view the recorded file. You can use the internal MATLAB movie viewer or an external video player.

Caution You must have the Indeo 5 video codec installed to decompress and play back a compressed animation recording.

Matching Playback Speed to Simulation Speed

Your computer will play back an AVI animation recording at 15 frames per second of real (clock) time, regardless of the simulation speed or visualization sample time during recording.

To guarantee that the animation playback show the simulation in real (clock) time, before recording, set:

- The model output sample time to be 1/15th of a second.
- The visualization sample time to be equal to or less than the model output sample time.

See “Changing How the Animation Is Updated” for more about sample times.

SimMechanics Visualization Menus and Their Controls

In this section...
“About the Visualization Window Menus” on page 2-32
“View Menu” on page 2-33
“Simulation Menu” on page 2-34
“Model Menu” on page 2-36
“Help Menu” on page 2-37

About the Visualization Window Menus

The menus of the visualization window group similar functions and contain all visualization functions.

Some menu items have a default setting. Others do not, as indicated by a “—” entry for the default in the menu tables following.

Menu Group	Feature or Function
View	Change camera viewpoint or frame; manipulate camera view; change background
Simulation	Control simulation; change dynamic camera response to animation; record animations
Model	Change display of body components and geometries; change common visualization-model features
Help	Get visualization help

Persistent Settings Versus Immediate Action

In most situations, all menu items are enabled in the sense that you can activate it. In some conditions, a menu item can be disabled, and you cannot activate it.

Some menu items control a persistent setting and switch between active and not active; for example, **Enable Model Highlighting**. By selecting the item, you either activate it, and a check mark appears; or you deactivate it, and the check mark disappears.

Other menu items, when you select them, instead trigger an immediate action, for example, **Simulation > Start**.

View Menu

This menu allows you to control two distinct visualization features, the camera viewpoint and frame and the background color.

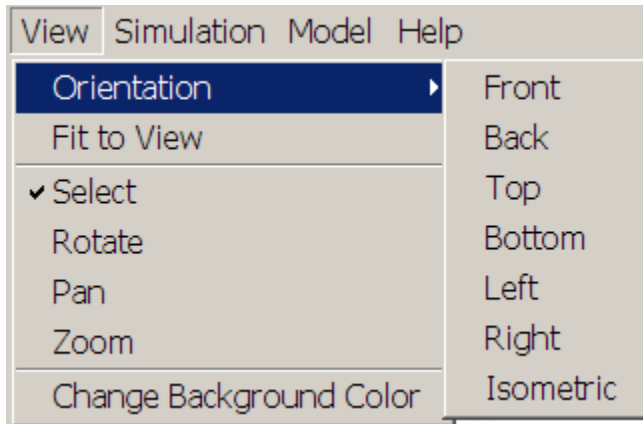

Menu Item	Function	Default
Orientation submenu: Front, Back, Top, Bottom, Left, Right, Isometric	Set camera viewpoint. One choice is always active, and the choices are mutually exclusive.	Front
Fit to View	Resize camera field to closely fit the bodies as viewed. Applies immediately.	—
Current Tool:	Enable mouse point-and-click tool. The choices are mutually exclusive, and can all be unselected (deactivated).	—
Select	Select objects in the display window.	Selected
Rotate	Rotate camera viewpoint.	Unselected
Pan	Pan camera field laterally and vertically.	Unselected
Zoom	Zoom in and out of camera field.	Unselected
Change Background Color	Open color palette to choose background color.	—

Simulation Menu

This menu allows you to control the simulation, the dynamic camera field, and the recording of the animation.

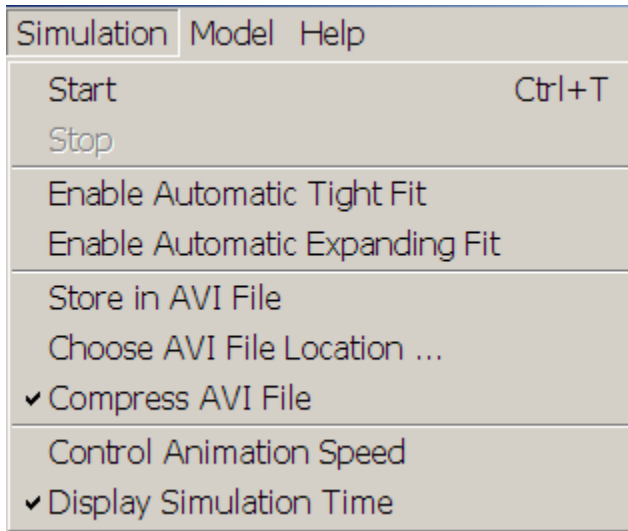

Menu Item		Function	Default
Simulation start, pause, and stop	Start	Start simulation. Appears and enabled only when simulation is stopped. Applies immediately. Keyboard equivalent is Ctrl+T .	—
	Pause	Pause simulation. Appears and enabled only when simulation is running. Applies immediately.	—
	Stop	Stop simulation. Enabled only when simulation is running. Applies immediately. Keyboard equivalent is Ctrl+T .	—
Dynamic camera field		Enable adaptive dynamic camera field during animation. The choices are mutually exclusive, and can all be unselected (deactivated).	Fixed camera field, viewpoint, and zoom; camera at rest in World.

Menu Item		Function	Default	
	Enable Automatic Tight Fit	Enable automatic resizing and zooming of camera field to keep moving bodies in fit-to-view field at all simulation times. Virtual camera moves with overall model motion with respect to World.	Unselected	
	Enable Automatic Expanding Fit	Enable automatic expansion of camera field to keep moving bodies in field at all simulation times. Virtual camera remains at rest with respect to World.	Unselected	
Store in AVI File		Record and save animation in AVI file.	Unselected	
Choose AVI File Location		Choose nondefault location for AVI file.	Default location for saved AVI file is current working MATLAB folder.	
Compress AVI File		Apply compression to saved AVI recording of animation.	Selected	
Control Animation Speed		Opens Animation speed control parameters dialog. Applies immediately.	Visualization sample time (s)	0
			Delay per frame (ms)	3
			Number of skipped frames per update	0
Display Simulation Time		Show simulation time in lower-right corner of full window.	Selected	

Start–Pause–Stop Menu During Simulation

During simulation, the start–pause–stop part of the **Simulation** menu looks like this:

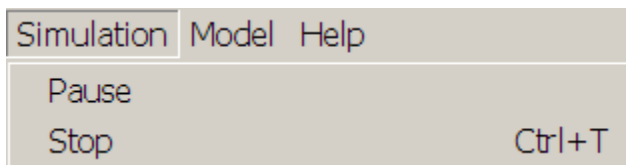

Animation Speed Control Parameters Dialog

The **Control Animation Speed** menu item opens the Animation Speed Control Parameters dialog:

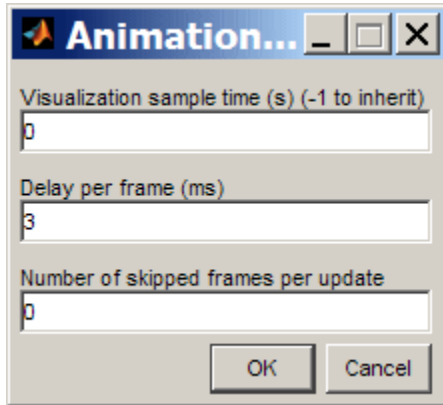

See “Controlling Animation”.

Model Menu

This menu allows you to control the display of body geometries and body components, as well as communicate from the visualization window to the model.

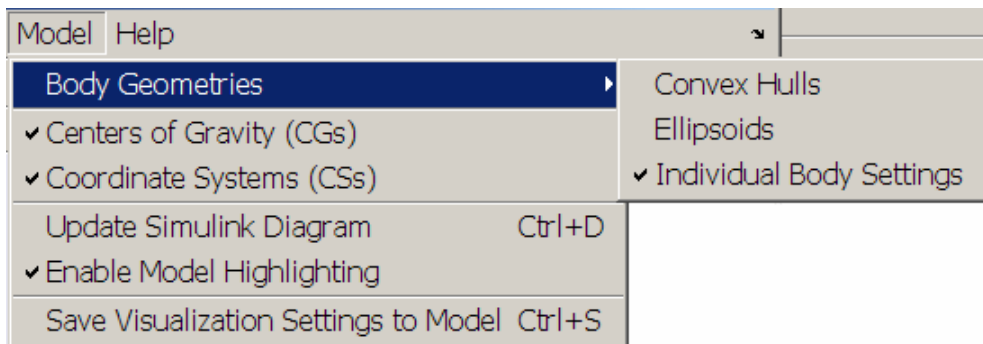

Menu Item	Function	Default
Body Geometries submenu:	Set geometries of visualized bodies.	—

Menu Item	Function	Default	
	One choice is always active, and the choices are mutually exclusive.		
	Convex Hulls	Visualize all bodies in window as convex hulls.	Unselected
	Ellipsoids	Visualize all bodies in window as equivalent ellipsoids.	Unselected
	Individual Body Settings	Visualize all bodies in window according to their respective Body block visualization settings.	Selected
Centers of Gravity (CGs)	Display centers of gravity of all visualized bodies.	Selected	
Coordinate Systems (CSs)	Display all Body coordinate systems attached to all visualized bodies.	Selected	
Update Simulink Diagram	Apply Update Diagram command to model. Applies immediately. Keyboard equivalent is Ctrl+D . Model equivalent is Edit > Update Diagram .	—	
Enable Model Highlighting	Enable automatic Body block highlighting when visualized body is selected in display window.	Selected	
Save Visualization Settings to Model	Save current state of visualization window controls to model. Applies immediately. (You need to save the model itself to save the settings permanently.)	—	

Help Menu

This menu allows you to get online help for the visualization window. Selecting **Open Visualization Help** immediately opens the Help browser to the SimMechanics visualization documentation.

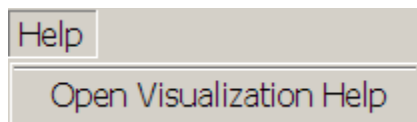

Customizing Visualization and Animation

You can customize the colors and geometries of visualized bodies in the SimMechanics visualization window. Choice of colors is intrinsic to visualization. Specifying a custom body geometry requires an external graphics file for each customized body.

As an alternative to the visualization window, you can also visualize your mechanical system with virtual reality.

- “About Custom SimMechanics Visualization” on page 3-2
- “Customizing Visualized Body Colors” on page 3-4
- “Customizing Visualized Body Geometries” on page 3-7
- “Visualizing with a Virtual Reality Client” on page 3-12
- “Reference” on page 3-26

About Custom SimMechanics Visualization

In this section...

“Customizing Visualization Settings” on page 3-2

“Creating an External Virtual Reality Client” on page 3-3

Customizing Visualization Settings

You can customize the way that SimMechanics visualization displays bodies, in terms of their colors and geometry. The geometry is composed of the body's size and shape.

- You can adjust the body color on a model- or machine-wide basis, or on an individual body basis.
- With an external graphics file referenced by a Body block, the visualization window can visualize the body with whatever shape the graphics file specifies.

For more information about starting visualization for a SimMechanics model, review the section Starting Visualization.

Model- and Machine-Wide Body Color and Geometry Controls

The model–machine–body hierarchy controls the model- and machine-default body colors and geometries. See “Hierarchy of Body, Machine, and Model Visualization Settings”.

To control visualization settings for an entire model or machine, you need to revisit the following two dialogs. These controls allow you to set a single default color and a single default standard geometry for all the bodies in a model or in a machine.

- To set a model-wide default body color and geometry, use the **Visualization** area of the **SimMechanics** node of the Configuration Parameters dialog.

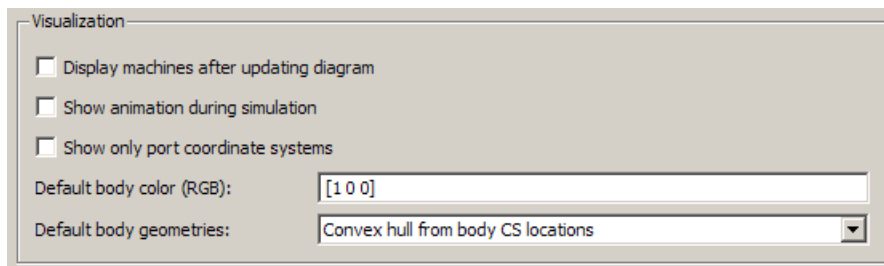

- To set machine-wide default body color and geometry, use the **Visualization** tab of that machine's Machine Environment block dialog.

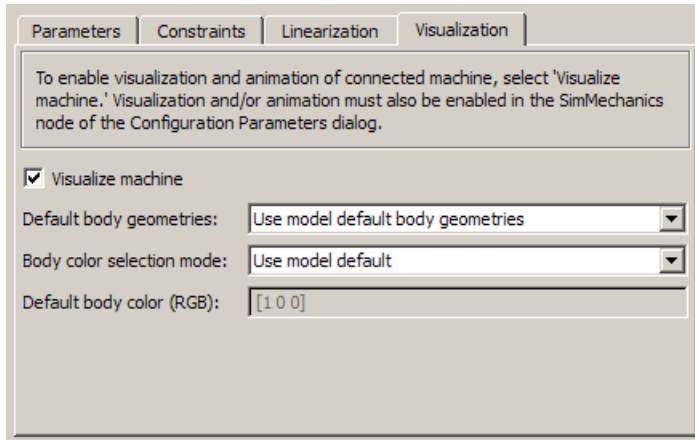

Creating an External Virtual Reality Client

You can bypass standard SimMechanics visualization by creating a virtual reality world of your own design to visualize your model's bodies. You can then build a custom interface from your model to the virtual world and animate its virtual bodies. See the final section, “Visualizing with a Virtual Reality Client”.

Customizing Visualized Body Colors

In this section...

“Choosing Custom Body Colors” on page 3-4

“Switching Between Default and Custom Body Colors” on page 3-4

Choosing Custom Body Colors

SimMechanics visualization has two formats for specifying a color.

MATLAB ColorSpec Vector

You specify colors by RGB values according to the MATLAB Graphics `ColorSpec` for

- An entire model, in the **Visualization** area of the **SimMechanics** node of the Configuration Parameters dialog.
- An entire machine, in the **Visualization** tab of that machine's Machine Environment block dialog.

The RGB (red–green–blue) triple of values is a vector $[r \ g \ b]$, with each value separately satisfying $0 \leq r, g, b \leq 1$.

- Red, green, and blue are $[1 \ 0 \ 0]$, $[0 \ 1 \ 0]$, and $[0 \ 0 \ 1]$, respectively.
- Black and white are $[0 \ 0 \ 0]$ and $[1 \ 1 \ 1]$, respectively.
- Other valid triples specify nonfundamental colors.

Color Palette Interface

You specify colors for individual bodies by visual inspection in the color palette in their respective Body dialogs.

Switching Between Default and Custom Body Colors

The SimMechanics visualization initial default color for visualized bodies is red (RGB of $[1 \ 0 \ 0]$).

Changing the Default Color for All Bodies in a Model

You can change the initial default to a different default color for all visualized bodies in a model.

- 1 Open the Configuration Parameters dialog, then go to the **SimMechanics** node.
- 2 In the **Visualization** area, change the **Default body color** RGB vector to a different, valid vector of values.
- 3 Click **Apply** or **OK**.

Note: You can override the model-wide default body color, both for a whole machine and for individual bodies.

Changing the Default Color for All Bodies in a Machine

The initial default is for a machine to inherit its model-wide body color. You can override the initial default by specifying a different machine-wide default color for all the bodies in one machine in your model.

- 1 Open that machine's Machine Environment block dialog and click its **Visualization** tab.
- 2 In the **Body color selection mode** pull-down menu, choose **Specify**. The **Default body color** field becomes active.
- 3 Change the RGB vector to a different, valid vector of values.
- 4 Click **Apply** or **OK**.

Note: You can override the machine-wide default body color for any individual body within the machine.

Changing the Color of an Individual Body

The initial default is for a Body to inherit its machine-wide body color. You can override the initial default by specifying a different color for an individual visualized body.

- 1 Open the Body block dialog and click its **Visualization** tab.
- 2 In the **Body color** pull-down menu, choose **Use color palette**. The color palette button appears.
- 3 Click the color palette button. The color palette opens.
- 4 Select a color from the palette and click **OK**.
- 5 To save the changes to the Body block and the model, click **OK** on the Body dialog.

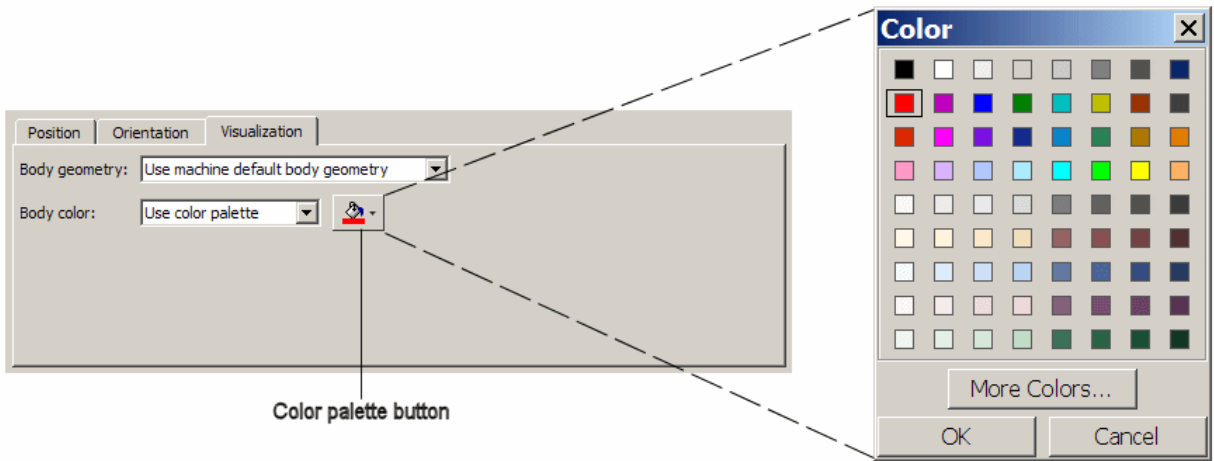

Body Dialog: Visualization Tab and Body Color Palette

Customizing Visualized Body Geometries

In this section...

“Choosing Custom Body Geometries” on page 3-7

“Switching Between Standard Body Geometries” on page 3-7

“About STL Body Graphics Files” on page 3-8

“Obtaining STL Body Graphics Files for Custom Body Geometries” on page 3-9

“Switching Between Standard and Custom Body Geometries” on page 3-10

Choosing Custom Body Geometries

Using body mass and geometry information from the Body block alone, the SimMechanics visualization window allows you two choices of standard body geometry, the convex hull and the equivalent ellipsoid.

You also have the choice of a nonstandard body geometry specified by an external graphics file.

Switching Between Standard Body Geometries

The SimMechanics initial default body geometry for visualized bodies is the convex hull.

Changing the Default Geometry for All Bodies in a Model

You can change the initial default of convex hulls to equivalent ellipsoids for all visualized bodies in a model.

- 1 Open the Configuration Parameters dialog, then go to the **SimMechanics** node.
- 2 In the **Visualization** area, select **Equivalent ellipsoid** from mass properties from the **Default body geometries** pull-down menu.
- 3 Click **Apply** or **OK**.

Note: You can override the model-wide default body geometry, both for a whole machine and for individual bodies.

Changing the Default Geometry for All Bodies in a Machine

The initial default is for a to inherit its model-wide body geometry. You can override the initial default by specifying a different machine-wide default geometry for all the bodies in one machine in your model.

- 1 Open that machine's Machine Environment block dialog and click its **Visualization** tab.
- 2 In the **Default body geometries** pull-down menu, choose a new machine-wide default, either **Convex hull from body CS locations** or **Equivalent ellipsoid from mass properties**.
- 3 Click **Apply** or **OK**.

Note: You can override the machine-wide default body geometry for any individual body within the machine.

Changing the Geometry of an Individual Body

The initial default is for a Body to inherit its machine-wide body geometry. You can override the initial default by specifying a different geometry for an individual visualized body.

- 1 Open the Body block dialog and click its **Visualization** tab.
- 2 In the **Body geometry** pull-down menu, choose either **Convex hull from body CS locations** or **Equivalent ellipsoid from mass properties**.
- 3 Click **Apply** or **OK**.

About STL Body Graphics Files

SimMechanics visualization supports the specification of body geometry (size and shape) with stereolithographic (STL) files in either ASCII or binary format. Each body with a custom geometry requires one STL file to provide this geometry.

Stereolithography specifies the three-dimensional surface geometry of a body by linked triangles whose edges and vertices are oriented by the right-hand rule. The orientation defines an “outside” and an “inside” of the surface. The edges and vertices of the elementary triangles join to form a continuous surface. A closed surface of such linked triangles approximates a body's smooth curved surface.

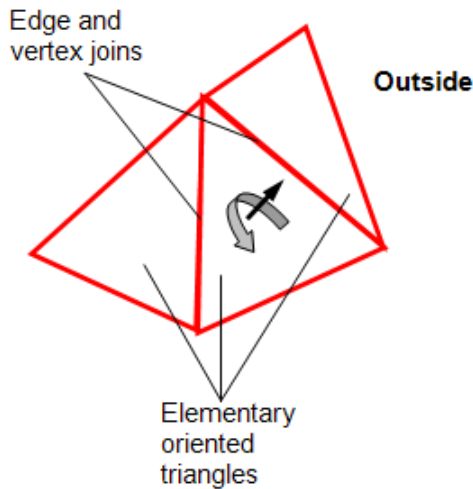

Stereolithographic triangles have some similarity to convex hulls. But convex hulls are directly and solely determined by the origins of the Body coordinate systems. Convex hulls are not necessarily made up of triangles. An STL file can specify an arbitrary number of elementary oriented triangles with vertices at arbitrary points in space. These vertices have no necessary connection to the Body coordinate systems.

Obtaining STL Body Graphics Files for Custom Body Geometries

You can obtain STL body geometry files from a number of sources.

- You can write a new STL file as a text file, following the STL standard.
- You can generate an STL file from many mechanical design applications, such as computer-aided design (CAD) platforms.
- The SimMechanics Link utility exports an STL file for each part in a CAD assembly. The CAD platform must be linked to the SimMechanics Link utility.
- You can reuse existing STL files, possibly with your own modifications. You can obtain such STL files from SimMechanics examples, other applications, and CAD-oriented Web sites.

Note: Refer to the SimMechanics Link documentation for more information about exported STL files.

Switching Between Standard and Custom Body Geometries

You can switch from the standard body geometries to a custom body geometry by changing the Body block to reference an external body geometry file. This custom body geometry specification overrides the model- and machine-wide defaults, but only for this body.

Requirements for External Body Geometry Files

The external body geometry file must be in STL format.

Caution In order for custom visualization to work, this STL file must be either:

- On your MATLAB path.
- In your MATLAB present working folder.
- Specified with complete path in the Body dialog.

Otherwise, visualization reverts to the default body geometry.

Specifying an External Body Geometry File

- 1 Open the Body block dialog and click its **Visualization** tab.
- 2 In the **Body geometry** pull-down menu, choose **External graphics file**.

The **External graphics file** field and **Attached to Body CS** pull-menu appear.
- 3 Enter the graphics file name and any necessary path in the field.
- 4 From the pull-down menu, choose which Body CS to attach the graphics to. (The Body CSs are listed in the Body's **Position** tab.) This Body CS serves as the reference for the origin, coordinate axes, and units of the body geometry.
- 5 Click **Apply** or **OK**.

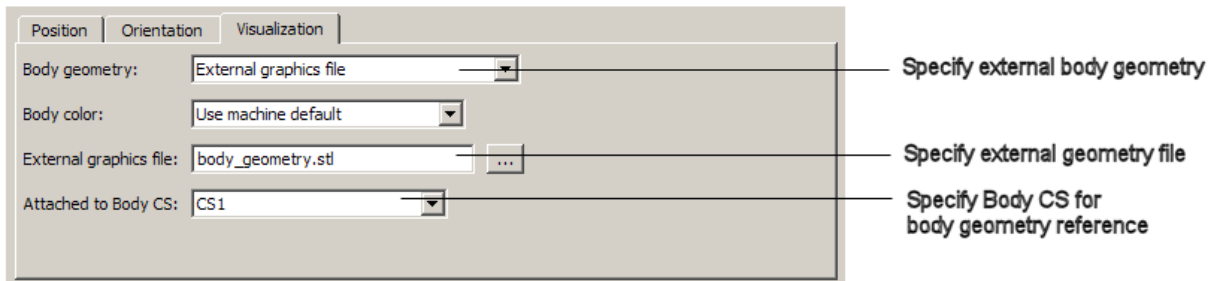

Body Dialog: Visualization Tab and External Body Geometry Reference

Attached Body Coordinate System as Geometric Reference for the Body Geometry File

The external graphics file has no intrinsic geometric origin, orientation, or units. The attached Body CS provides an origin, axis directions (orientation), and units of length to interpret the geometric information specified by the external graphics file.

Tip If you need a body geometry origin, orientation, or system of units that is not represented in your current list of Body coordinate systems, create a new Body CS in the **Position** tab with the geometric features you want. You can make this Body CS invisible on the Body block if you wish.

Visualizing with a Virtual Reality Client

In this section...

“About Virtual Worlds for Machines and Models” on page 3-12

“Creating Virtual Worlds for SimMechanics Models” on page 3-12

“Interfacing SimMechanics Models with Virtual Worlds” on page 3-14

“Creating and Interfacing a Model Virtual World” on page 3-16

About Virtual Worlds for Machines and Models

You can bypass SimMechanics visualization and create a mechanical animation in a virtual world of your own design. You create a virtual world, populate it with bodies represented as virtual objects using Virtual Reality Modeling Language (VRML), then interface the virtual world with your SimMechanics model. Creating your own virtual animation requires a new or existing virtual world for your model and an interface between them.

This section explains how to couple a separately created virtual world with a SimMechanics model.

Building Virtual Worlds This section assumes that Simulink 3D Animation software is installed on your system and that you are familiar with it and with creating virtual worlds. Refer to the Simulink 3D Animation documentation for full details on installing and using this toolbox.

We recommend you allocate generous central processor power, graphics card speed, and memory for virtual reality visualization, especially for animation.

Creating Virtual Worlds for SimMechanics Models

The Simulink 3D Animation documentation and VRML books [1] explain how to create virtual objects and assemble them into virtual worlds. A displayed virtual world is called a *virtual scene*. The best way to become comfortable moving around in a virtual world is to practice with a variety of movement modes and viewpoints. This section highlights the requirements to make a virtual world usable as a visualization for a SimMechanics model.

Editing Virtual Worlds and VRML Files

As you create a virtual world populated by virtual bodies, you must create each component body, then plan and implement the geometry of the bodies' initial state. Use a VRML authoring tool that can read VRML as a native format to create and edit virtual reality `.wrl` files. Simulink 3D Animation software includes a VRML authoring tool called V-Realm Builder[®]. If you are familiar with native VRML source code, you can use a plain text editor or the MATLAB editor to edit the files.

Representing Bodies as Virtual Objects

You represent each body by a virtual object encoded in a `.wrl` file. You also create a master `.wrl` file to represent the virtual world that refers to body `.wrl` files, placing and orienting these bodies in the larger scene. You can define a body's position and orientation with respect to:

- The overall virtual world, corresponding to the SimMechanics coordinate system World.
- Another body in the machine, corresponding to SimMechanics Body coordinate systems.

You can nest body references to other bodies in VRML hierarchies, but you must define at least one body's position and orientation with respect to the overall virtual world. Place and orient the bodies in their initial states, corresponding with the initial state of the SimMechanics simulation.

Each body's `.wrl` file contains a hierarchical tree starting with the Transform node. Among Transform's fields must be translation and rotation fields to specify the body's position and orientation in space. If a body is nested below another body, its position and orientation are defined with respect to the next body up the hierarchy.

Creating your own virtual world gives you great flexibility in representing your machine:

- You can display bodies in as much or as little detail as you want, with shapes, colors, textures, etc., of your own choosing.
- You can include or omit bodies as desired.
- You can create a computer-aided design (CAD) assembly of your machine and export it into VRML files.
- If you only translate a body, you can omit the rotation field from its Transform node.
- If you only rotate a body, you can omit the translation field from its Transform node.

Interfacing SimMechanics Models with Virtual Worlds

To animate a body, you need to measure its motion in your SimMechanics simulation and export that information to the virtual world. This requires connecting Body Sensor blocks to the Bodies you want to animate in your model, then creating an interface that animates the virtual bodies with the body sensor motion signals. “Interfacing the Model and the Virtual World” applies these steps to the `mech_conveyor_vr` example.

Adding and Configuring Body Sensors

Connect the Body Sensors to Body coordinate systems (CSs) on the bodies whose motions you want to animate. The Body block reference discusses how to create and configure Body CSs. You need to take these extra steps to export the signals of a body sensor to your virtual world:

- 1 Make sure the Body Sensor's Body CS reference origin and orientation follow the body's defining VRML hierarchy.

Example: You define a new Body CS on a body to connect the Body Sensor. If you defined the VRML body's position with respect to the center of gravity (CG) of a second, neighboring body in your VRML files, you should set the **Translated from origin of** field of the new Body CS to the origin of the CG CS of the second body.

- 2 In the Body Sensor dialog, select the **[x; y; z] Position** check box if you want to animate the body's translational motion.

Select the **[3 x 3] Rotation matrix** check box if you want to animate the body's rotational motion.

- 3 Choose the coordinate system in which the body motions are measured in the **With respect to coordinate system** pull-down menu. You can pick **Absolute (World)** or **Local (Body CS)**. This coordinate system should be the same as the coordinate system used to define the body's position and orientation in the VRML files.

A Simulink output port \gt appears on the block for each of the motion signals. The translational signal is a 3-vector of spatial coordinates, (x, y, z) . The rotational signal is a 9-vector, column-wise representation of the 3-by-3 orthogonal rotation matrix R , $(R_{11}, R_{21}, R_{31}, R_{12}, \dots)$.

Animating the Virtual World Bodies

Animating the virtual bodies requires interfacing the body sensor signals in the SimMechanics model with the VRML translation and/or rotation fields in the `.wrl` files.

You accomplish this with the VR Sink block, which you can find in the Simulink 3D Animation block library.

- 1 Enter `vrlib` at the command line. Drag a copy of the VR Sink block into your model.
- 2 Open the VR Sink dialog box. (The figure “Conveyor Loader Model: VR Sink Dialog Box” displays an example of the dialog.)
- 3 In the **Source file** field in the **World properties** area, enter the name of the VRML file that represents your model's virtual world. This is the file that refers to the other `.wrl` files representing the component bodies of your machine. If the virtual world VRML file is not in the same folder as your model, enter the file's path relative to the model.

Click **Apply**. In the **VRML Tree** window, the node list of the virtual world `.wrl` file appears.

- 4 Expand the tree of each component body in the list to view that body's check box list. Select the **rotation** and/or **translation** check boxes as needed for each body. A Simulink input port \triangleright appears on the block icon for each of these selected check boxes.

The ports are labeled **node.field**. The **node** is the name for the body. The **field** is named either `rotation` or `translation`.

Converting Body Sensor Signals into VRML Format

You are now ready to connect the Body Sensor output signals to the VR Sink block. But you might need to modify those signals for valid use in VRML.

- You can connect the translational motion signal line directly from the output port of the Body Sensor to the **node.translation** input port on the VR Sink. The VRML node tree directly accepts translation motion as a 3-vector signal of rectangular coordinates (x,y,z) .

Make sure that the translational motion signal refers to the same coordinate system used to define the body's position in the VRML files.

- You cannot directly connect the rotational motion signal line to the VR Sink. The Body Sensor output represents orientation with a 3-by-3 rotation matrix R , while VRML accepts orientation represented as the axis-angle 4-vector form $[\mathbf{n} \theta]$, where $\mathbf{n} = (n_x, n_y, n_z)$ is a 3-vector representing the rotation axis and θ is the rotation angle.

Open the SimMechanics Utilities library. For each rotational motion signal, drag a `RotationMatrix2VR` block into your model. Connect the rotation signal from the

Body Sensor block to the RotationMatrix2VR block. Then connect the latter block to the corresponding `node.rotation` input port on VR Sink for that body. This block converts the 3-by-3 R matrix signal into the 4-vector VRML form.

Close the VR Sink block dialog. Your SimMechanics model now animates the virtual world.

Creating and Interfacing a Model Virtual World

The model `mech_conveyor_vr` is a modified version of the original conveyor model `mech_conveyor`.

Viewing the Custom External VRML Files

The `mech_conveyor_vr` model comes with external VRML files containing static geometries of the machine parts in their initial positions. This example uses the V-Realm Builder editor to view the files.

- 1 In the `matlabroot\toolbox\physmod\mech\mechdemos\` folder, open these external VRML files with V-Realm Builder:

```
base.wrl, convmech.wrl, link1.wrl, link2.wrl, link3.wrl,  
link4.wrl, pusher.wrl
```

- 2 With the `convmech.wrl` world in focus, click the **Test Mode** button  in the V-Realm Builder toolbar and view the complete machine in the **Main** view. Right-click in this window to configure the navigation. If the colors seem washed out, disable the headlight.

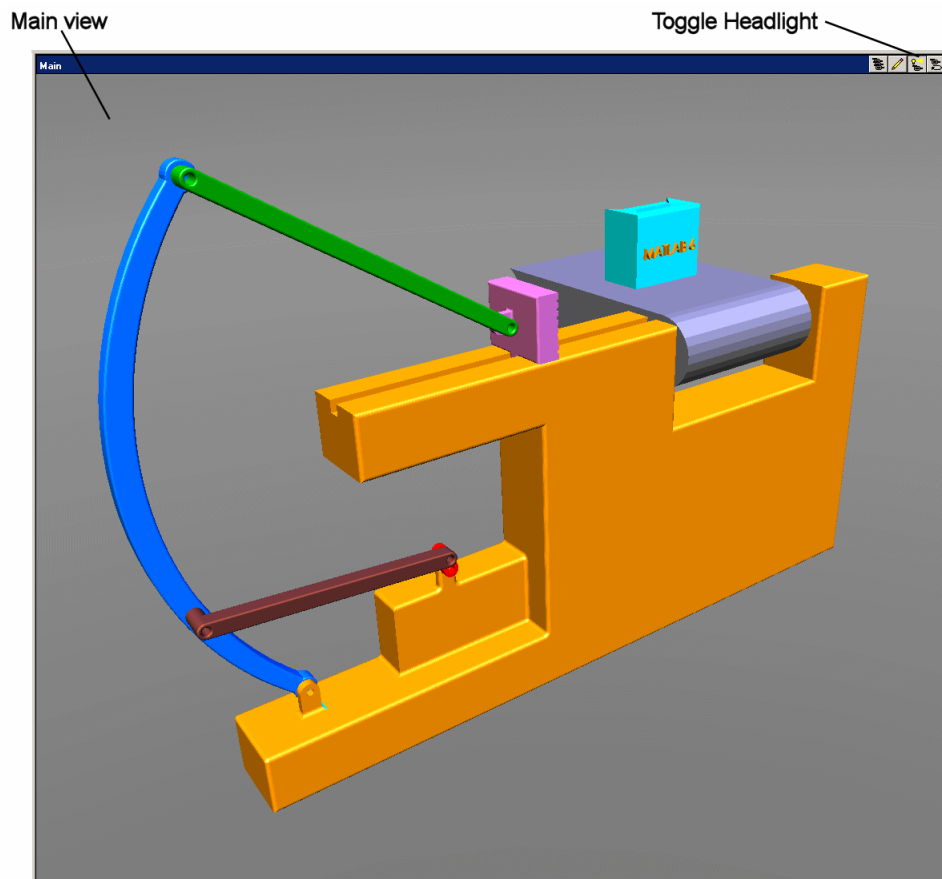

- 3 On the left side of your VRML editor window, examine the node tree of `convmech.wrl` that refers to the six VRML files representing each component body:

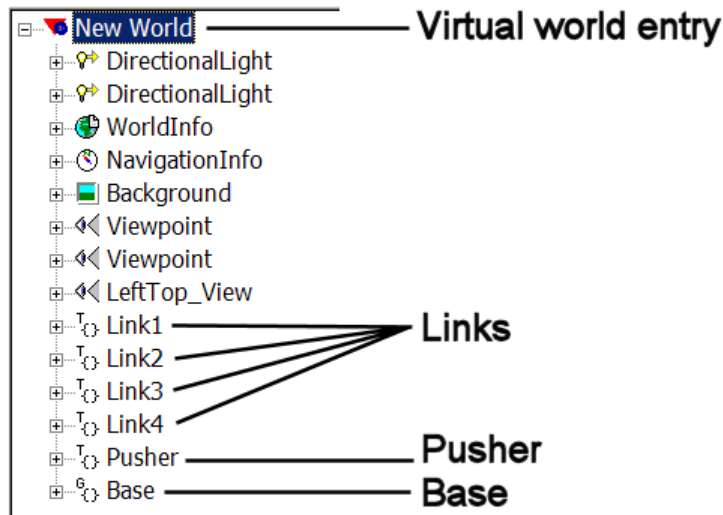

The hierarchy of body position and orientation references is flat in this model. Each body is separately referenced to the top level of the hierarchy, `New World`.

- 4 Expand one of the nodes. Each body node has, among others, rotation and translation fields:

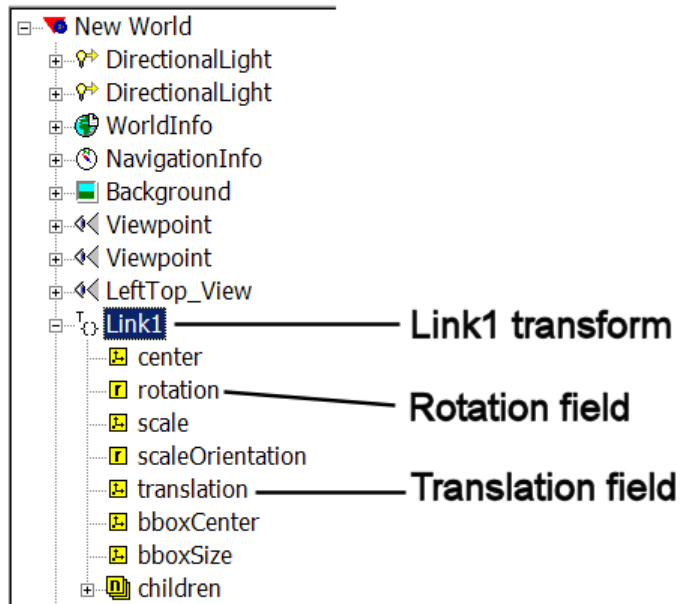

The exception is the base. Being grounded and immobile, it has neither a translation nor a rotation field.

Interfacing the Model and the Virtual World

In `mech_conveyor_vr`, open the `Body Sensor1` block. The block measures the translational and rotational motion of `Link3` in the conveyor:

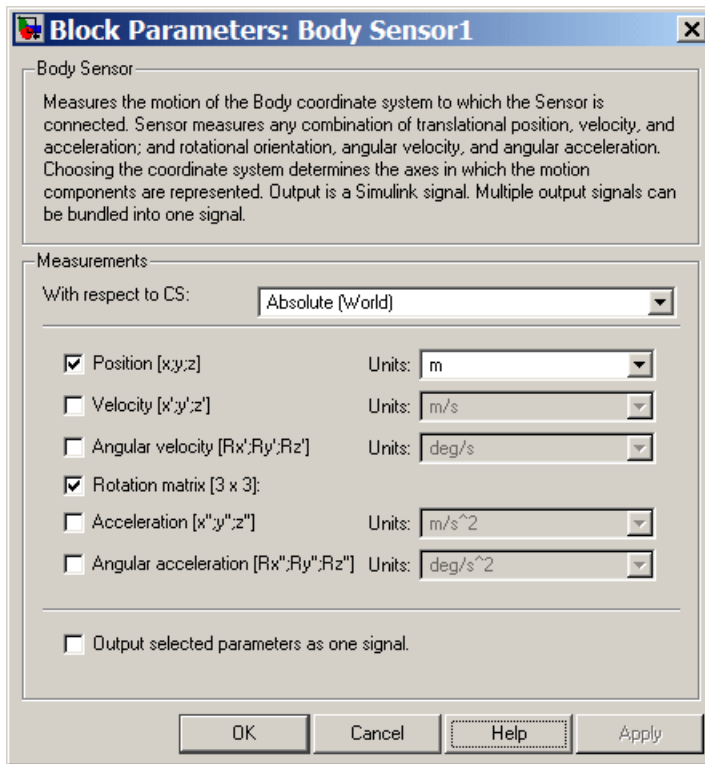

The Body Sensor1 block has two Simulink output signals.

The other Body Sensor blocks are similar, except for Body Sensor2, which measures only the translational motion of the pusher. All the Body Sensors measure body motions with respect to World, the frame in which the conveyor base is at rest. Each motion signal represents the body's displacement relative to its initial position.

The mech_conveyor_vr model contains a Simulink 3D Animation subsystem interfacing to the model's custom VRML files.

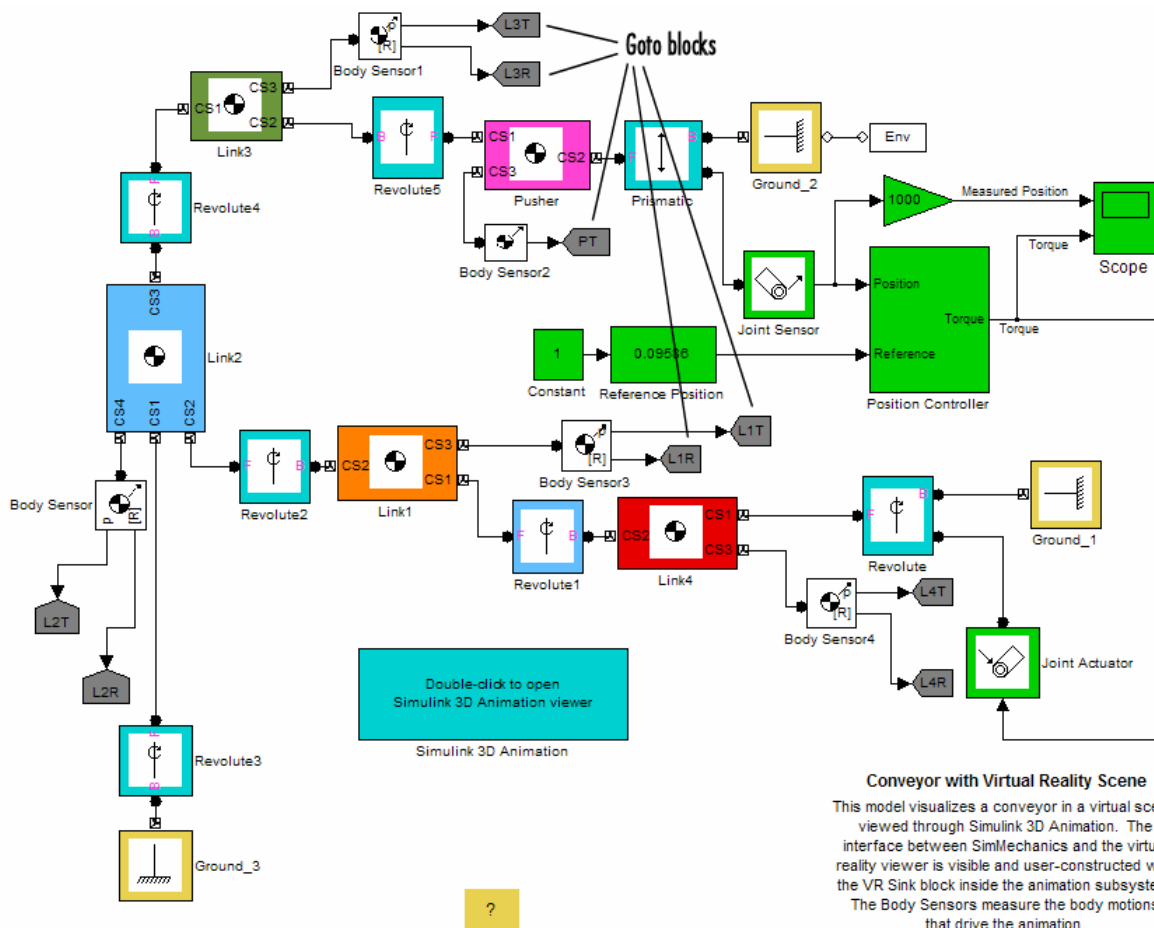

Conveyor with Virtual Reality Scene

This model visualizes a conveyor in a virtual scene viewed through Simulink 3D Animation. The interface between SimMechanics and the virtual reality viewer is visible and user-constructed with the VR Sink block inside the animation subsystem. The Body Sensors measure the body motions that drive the animation.

Double-click the Simulink 3D Animation block to open the virtual scene. Double-click the Scope block to see the scopes that measure the pusher position and controller torque.

Conveyor Loader Model with Custom Virtual Reality Animation Interface

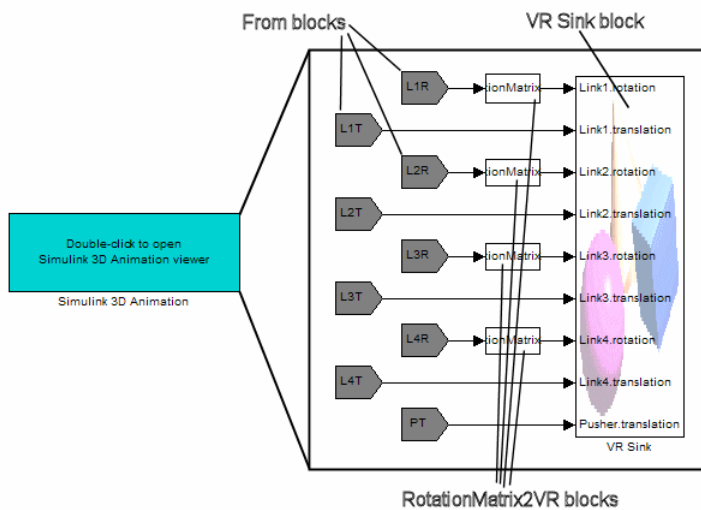

Custom Virtual Reality Animation Interface Subsystem

- 1 Trace each body sensor signal. The signals are routed through pairs of Simulink Goto blocks (in the model) and From blocks (in the custom library).
- 2 Open the Simulink 3D Animation subsystem, both by double-clicking its icon and by looking under its mask. The VR Sink block, connected to From blocks transmitting the body motion signals, and the virtual scene viewer appear. The conveyor loader virtual scene is similar to that visible in the VRML editor (see “Viewing the Custom External VRML Files”).

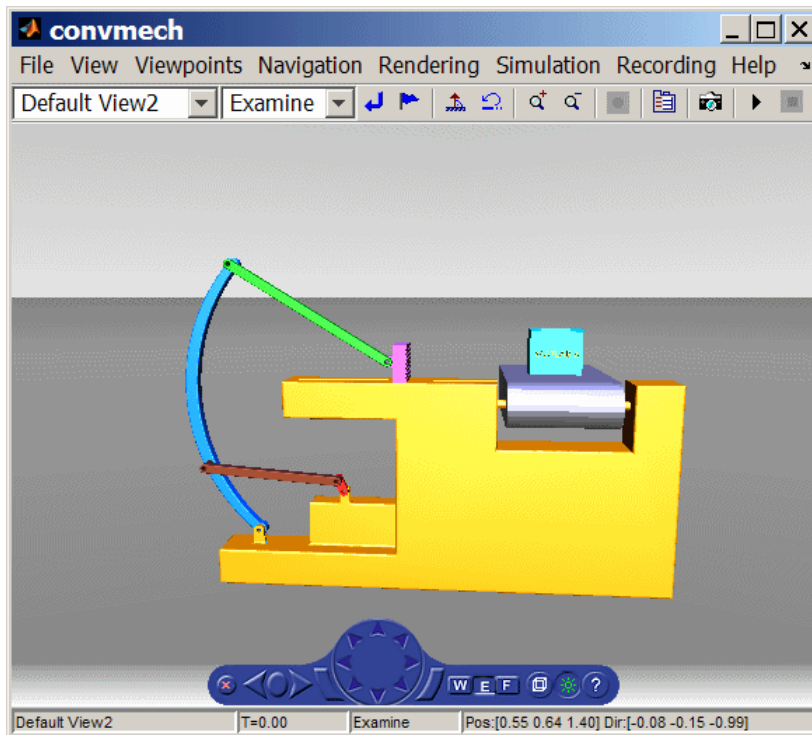

Conveyor Loader Model: Simulink 3D AnimationViewer

- 3 From the menu bar of the virtual scene viewer, select **Simulation**, then **Block Parameters**. The VR Sink block dialog opens.

The **Source file** is `convmech.wr1`, the master file for this virtual world. The **VRML Tree** on the right reproduces the node tree visible in the VRML editor for `convmech.wr1`.

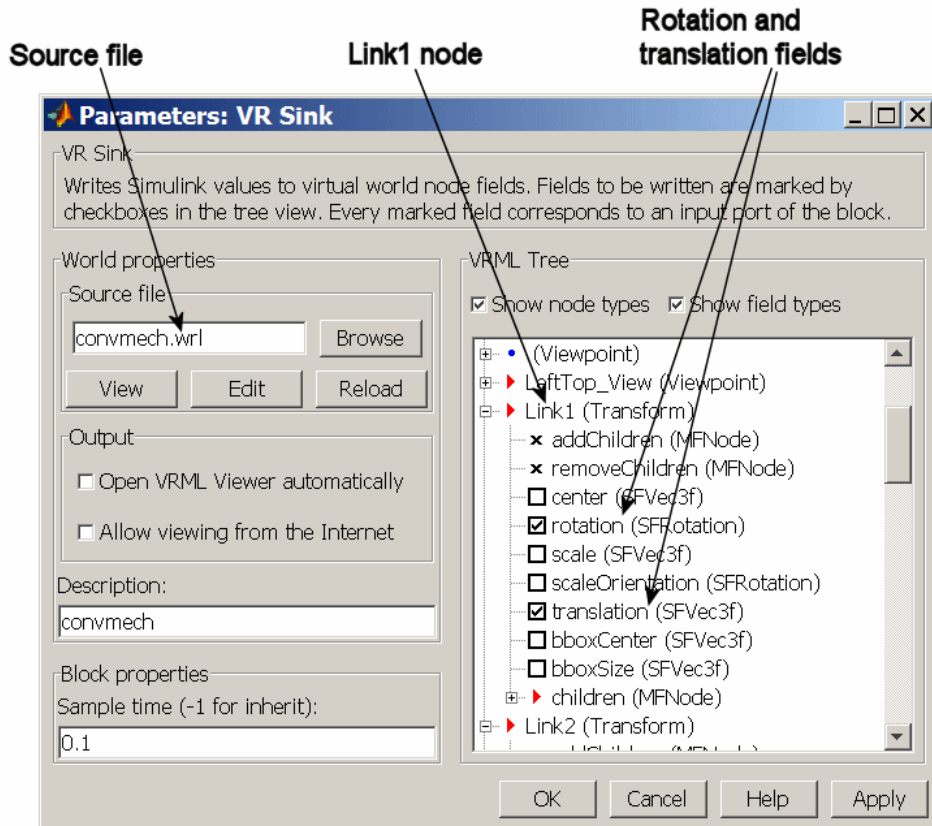

Conveyor Loader Model: VR Sink Dialog Box

- 4 Expand and scroll down the VRML trees. The trees for Link1, Link2, Link3, Link4, and Pusher list the field inputs for accepting motion signals.
 - The Link component bodies require both translational and rotational motions. All the Links have actively selected check boxes for their **rotation** and **translation** field inputs.
 - The Pusher body requires only translational motion. Only the **translation** field check box is selected for the Pusher.

Each of the nine Simulink input ports on the VR Sink block is named **node.field**. The Base of the conveyor does not move, so its node has no motion input fields.

- 5 If you closed the Simulink 3D Animation viewer, you can reopen it from the VR Sink dialog. Click **View** in the **World properties / Source file** area of the dialog.
- 6 Close all the dialog boxes by clicking **OK**, leaving the viewer open.
- 7 Click the **Start** button in the model window.

As in the original mech_conveyor example, starting the model opens the **Reference Position** slider bar that you can move from side to side. As you do so, watch the pusher in the viewer move in parallel.

Reference

- [1] Marrin, C., and B. Campbell, *Teach Yourself VRML 2 in 21 Days*, Indianapolis, Indiana, Sams, 1997.

Importing Mechanical Models

Using SimMechanics software with computer-aided design (CAD) extends your mechanical modeling and simulation capabilities, allowing you to create SimMechanics models from CAD assemblies. This chapter covers what you need to get started with CAD translation. It assumes some familiarity with SimMechanics modeling.

- “Mechanical Import” on page 4-2
- “Generating New Models from Physical Modeling XML” on page 4-6
- “Working with Generated Models” on page 4-11
- “Model Update with Physical Modeling XML” on page 4-20
- “Controlling Model Update at the Block Level” on page 4-29
- “Troubleshooting Imported and Updated Models” on page 4-41
- “Import a CAD Rigid Body” on page 4-45
- “Import Robot Arm Model” on page 4-46
- “Import a CAD Stewart Platform Model” on page 4-50

Mechanical Import

In this section...

“About Mechanical Import and CAD Translation” on page 4-2

“Requirements for CAD Export and Mechanical Import” on page 4-3

“Essential CAD Translation Steps” on page 4-4

About Mechanical Import and CAD Translation

SimMechanics software features an *importer* that lets you automatically generate SimMechanics models from an XML file in Physical Modeling format. This externally defined XML file specifies mechanical information — bodies, degrees of freedom, and geometry — in a form that the SimMechanics importer can use to construct a model representing that system.

The standard way to obtain such a Physical Modeling XML is to generate it by exporting a computer-aided (CAD) assembly. CAD tools allow you to model mechanical systems geometrically as collections of parts, or *assemblies*. You use Simulink and SimMechanics block diagrams to represent control systems composed of mechanical devices and simulate their dynamics. The block diagram approach does not include full geometric information, nor do CAD assemblies typically incorporate controllers or allow you to perform dynamic simulations. With CAD translation, you can combine the power of CAD and SimMechanics software.

The SimMechanics Link utility is the necessary intermediary that lets you convert CAD assemblies into SimMechanics models. The intermediate step between CAD assembly and SimMechanics model is exporting an XML file in Physical Modeling format from the assembly. The export also automatically creates STL files containing body geometry information that you need for visualizing the bodies in the model.

The SimMechanics importer then converts this XML file into a mechanical model, which references the STL files to visualize the bodies.

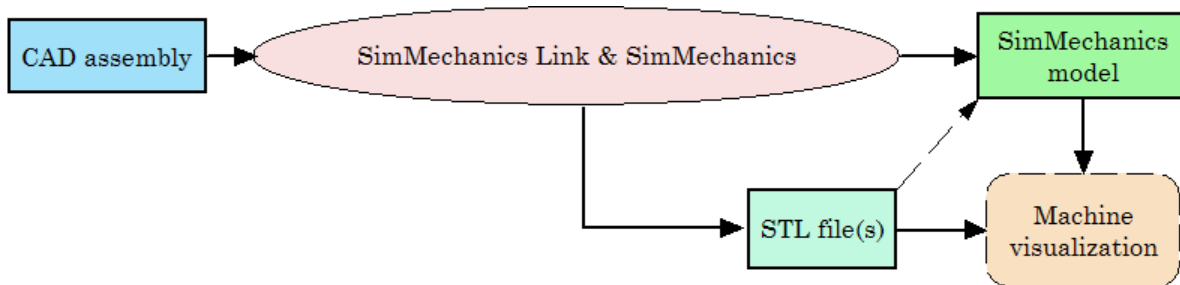

Complete Translation of CAD Assembly Into a Visualizable Model

Requirements for CAD Export and Mechanical Import

The full CAD translation is composed of two distinct steps, with different requirements.

- 1 The first step is the export of the CAD assembly, which creates the Physical Modeling XML file and one or more STL file(s).
- 2 The second step is the import of the Physical Modeling XML file and generation of the SimMechanics model.

CAD Export Software Requirements

To export a CAD assembly into XML, you must first

- 1 Install your CAD platform or software application.
- 2 Install the SimMechanics Link utility and link it to your CAD platform. The SimMechanics Link utility requires MATLAB only.

Note: For CAD export, you do not need Simulink or SimMechanics software.

Setting Up SimMechanics Link Software

To install and register SimMechanics Link, see “Install and Register SimMechanics Link Software”

Physical Modeling XML Import Software Requirements

To import a Physical Modeling XML file and generate a model, you must have installed Simulink and the Simscape™ and SimMechanics products.

Note: For XML import, you do not need a CAD platform or the SimMechanics Link utility.

Essential CAD Translation Steps

Converting a CAD assembly to a SimMechanics model requires two major steps, exporting the CAD assembly into XML, then importing the XML to create a SimMechanics model.

Exporting an Assembly to XML

You export the assembly from the CAD platform into a Physical Modeling XML file that you can later use with the SimMechanics importer. See the SimMechanics Link documentation.

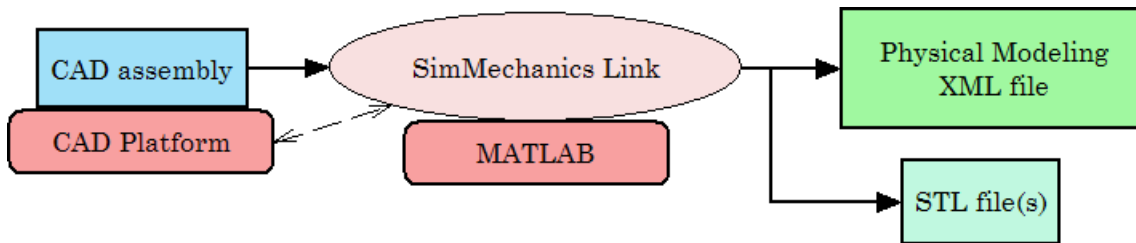

Exporting a CAD Assembly into a Physical Modeling XML File

Automatic Export of STL Files Representing CAD Part Geometries

When you export the CAD assembly into Physical Modeling XML, the SimMechanics Link exporter also automatically creates an STL body geometry file for each body represented as a CAD assembly part. You then need these STL files for SimMechanics visualization, once you create your SimMechanics model.

See “Referencing STL Body Geometry Files for SimMechanics Model Visualization”.

Importing the XML and Generating a Model

To complete the CAD translation, you convert the Physical Modeling XML file into a SimMechanics model. See “Generating New Models from Physical Modeling XML”.

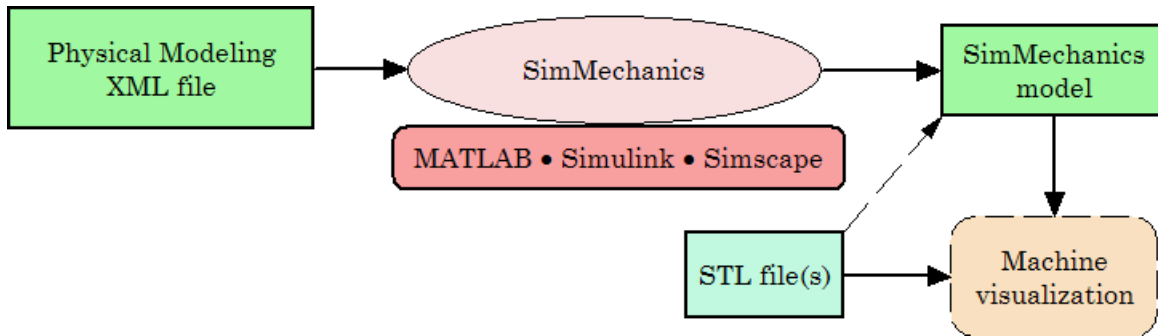

Importing a Physical Modeling XML File into a Model

Referencing STL Body Geometry Files for SimMechanics Model Visualization

Once you have imported the Physical Modeling XML to create a SimMechanics model, you can visualize the bodies in the model. The generated SimMechanics model automatically references the necessary STL body geometry files, one for each body, to visualize the bodies with their original CAD assembly shapes.

Generating New Models from Physical Modeling XML

In this section...

“About Generated SimMechanics Models Based on CAD” on page 4-6

“Generating a New Model from a Physical Modeling XML File” on page 4-6

“Controlling New Model Import” on page 4-8

About Generated SimMechanics Models Based on CAD

Note: For complete information on exporting Physical Modeling XML, see the SimMechanics Link documentation.

A computer-aided design (CAD) assembly can contain enough part and constraint information that you can generate a SimMechanics model consisting of Body and Joint blocks representing the assembly. Once you have exported a CAD assembly into a Physical Modeling XML file, you can generate a SimMechanics block diagram model from this file. A new generated model consists of a single SimMechanics machine, corresponding to an assembly with a single root.

This section shows you how to import the XML file into a SimMechanics model using the command `mech_import`, which constructs the model.

Requirements for Generating Models by Importing Physical Modeling XML

This section assumes that you have the SimMechanics product installed locally or remotely, and that you have:

- The XML file representing a CAD assembly
- Optionally, STL body geometry files associated with the CAD parts

To generate the SimMechanics model, you do not need the CAD platform or assembly from which the XML file was exported. You also do not need the SimMechanics Link utility.

Generating a New Model from a Physical Modeling XML File

You generate the CAD-based SimMechanics model using the `mech_import` command or dialog.

Using the Command Line

To start the model generation from a hypothetical XML file called `cad_assembly.xml`, enter

```
mech_import('cad_assembly.xml')
```

at the command line. A progress bar appears and is updated as the model is imported.

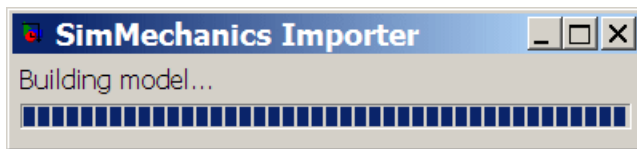

A Simulink model window opens. The model is populated by Bodies and Joints corresponding to the assembly parts and constraints saved in `cad_assembly.xml`. The name of the generated model is the name of the original assembly file, regardless of the name chosen for the XML file.

Using the Import Dialog

You can also select a Physical Modeling XML file and generate a model from it through the Import Physical Modeling XML dialog. Open it by entering `mech_import` at the command line with no arguments. See the `mech_import` command reference for complete information about the import dialog. After completing your settings, click **OK** to start the import.

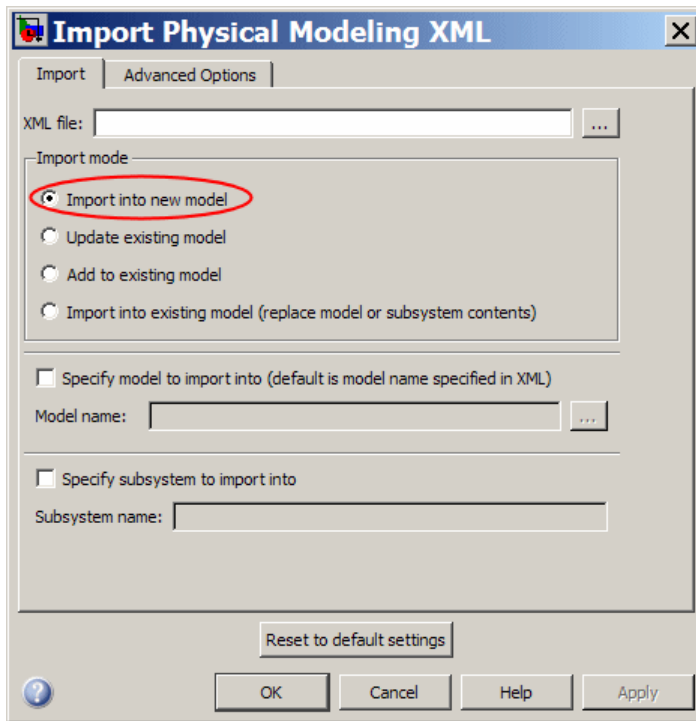

Controlling New Model Import

You have several options for changing the default import behavior of `mech_import` and the Import Physical Modeling XML dialog box. For more information, see “Nondefault Features in Generated Models” on page 4-14.

Customizing the Generated Model Name

You can specify the name of the generated model in the `mech_import` command or the import dialog. The default is to accept the assembly name specified in the XML file.

For example, an XML file called `cad_assembly.xml` could internally specify the assembly name as `CAD_Assembly`. Generating a model from this XML file leads to a model name of `CAD_Assembly`. But suppose you want to name it `assembly1` instead. Either:

- Enter at the command line

```
mech_import('cad_assembly.xml', 'ModelToImportInto', 'assembly1')
```

This starts the import of `cad_assembly.xml` and creates a model file called `assembly1.mdl` from it.

- In the dialog's **Import** tab, select the **Specify model to import into** check box. In the **Model name** field, enter `assembly1` and click **OK**.

Changing the Appearance and Layout of a Generated Model

The **Advanced Options** dialog tab displays model layout and block appearance controls in the **Layout** area. With these, you can make your generated model easier to view and understand. You can:

- Control how the importer names Joint blocks.
- Control the amount of space the importer creates between blocks.
- Control the direction in which the importer automatically adds blocks to the model.

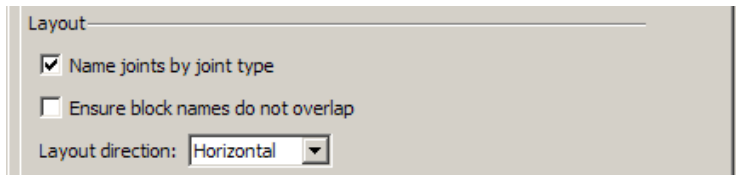

You can alternatively use the equivalent options in the `mech_import` function.

Importing into a Subsystem

By default, the importer generates the model starting at the top level of model hierarchy. It creates subsystems below that level if needed to translate subassemblies.

You can instead import the entire XML file into a subsystem, so that the top level of model hierarchy consists of just this subsystem. Subassemblies are then translated into sub-subsystems below that level. If you import into a subsystem, you must specify names for both the model and subsystem.

For example, you can import `cad_assembly.xml` into a subsystem called `assembly`, residing in a new model called `model_assembly`. Either

- Enter at the command line

```
mech_import('cad_assembly.xml', ...  
           'ModelToImportInto', 'model_assembly', ...  
           'SubsystemToImportInto', 'assembly')
```

This starts the import of `cad_assembly.xml` into the subsystem.

- In the dialog's **Import** tab,
 - Select the **Specify model to import into** check box. In the **Model name** field, enter `model_assembly`.
 - Select the **Specify subsystem to import into** check box. In the **Subsystem name** field, enter `assembly` and click **OK**.

Changing the Hierarchy of Moving Joints and Organization of Rigidly Connected Bodies

The **Advanced Options** dialog tab displays model simplification controls in the **Model simplification** area. With these, you can isolate moving bodies and their DoFs from the rest of the model. You can:

- Group Bodies rigidly connected by Welds into their own subsystems, each at the appropriate subsystem level.
- Import non-Weld Joints at the highest level possible, depending on whether you are importing a model or a subsystem, as well as group rigidly welded Bodies into their own subsystems. The importer promotes moving Joints in the model hierarchy regardless of where the corresponding degrees of freedom occur in the original assembly.

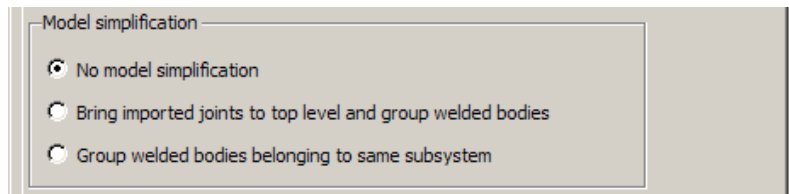

You can alternatively use the equivalent options in the `mech_import` function.

Working with Generated Models

In this section...

“About CAD-Based Models” on page 4-11

“Common Features of CAD-Based Models” on page 4-11

“Nondefault Features in Generated Models” on page 4-14

“Manually Modifying and Extending Generated Models After Import” on page 4-15

About CAD-Based Models

This section explores the characteristics of a generated CAD-based model, imported with default or nondefault settings. It also explains when and how to edit your model and expand it with additional blocks, such as Constraints, Drivers, Actuators, and Sensors. The section concludes by pointing out major model-generation and simulation errors and problems that can arise from CAD-based models, and techniques for solving them.

Common Features of CAD-Based Models

Note: This section assumes a model generated with default import settings and not yet edited manually. To see the effects of using nondefault import settings in a newly generated model, see “Nondefault Features in Generated Models” on page 4-14.

Most of the properties of models that you generate from an XML file are the same as the default properties of all Simulink models. For information on working with Simulink models, see the Simulink documentation.

SimMechanics models that are successfully generated from CAD-based Physical Modeling XML have certain common properties that reflect their origin in CAD assemblies:

- Machine Environment, Ground, Body, and Joint blocks only.
 - One Ground block and one connected Machine Environment block for each SimMechanics machine.
 - All other automatically generated SimMechanics blocks are Bodies and Joints only, corresponding to the parts, degrees of freedom (DoFs), and constraints of the Physical Modeling XML file imported.

- The minimum Body coordinate systems and grounded coordinate systems necessary to connect each Joint to exactly two coordinate systems, one on each side of the Joint.
- Unattached coordinate systems corresponding to reference coordinate systems in the original assembly and, in general, not associated with constraints.
- Fundamental root, represented by Ground – Root Weld – Root Body. The Root Body occurs at the top of the main hierarchy. The Root Body has no mass and no inertia, and does not move.
- Subsystems below the top level encapsulating subassemblies from the original assembly.
- Subassembly roots, represented by Root Body – Root Weld – Fixed Body. A Root Body occurs at the top of each subsystem hierarchy if you need such a body to correctly represent constraints in the original CAD assembly.
- Joints with DoFs containing the correct joint primitives for the translational and rotational DoFs between any two bodies.

If no appropriate specific Joint exists, the importer inserts a Custom Joint with the appropriate primitives.

- Joints without DoFs, represented by Welds.
- Apart from Root Body blocks, each Body block referencing its STL body geometry file.
- Both machine- and model-wide visualization enabled.

This is an example of a model generated from a robot arm assembly.

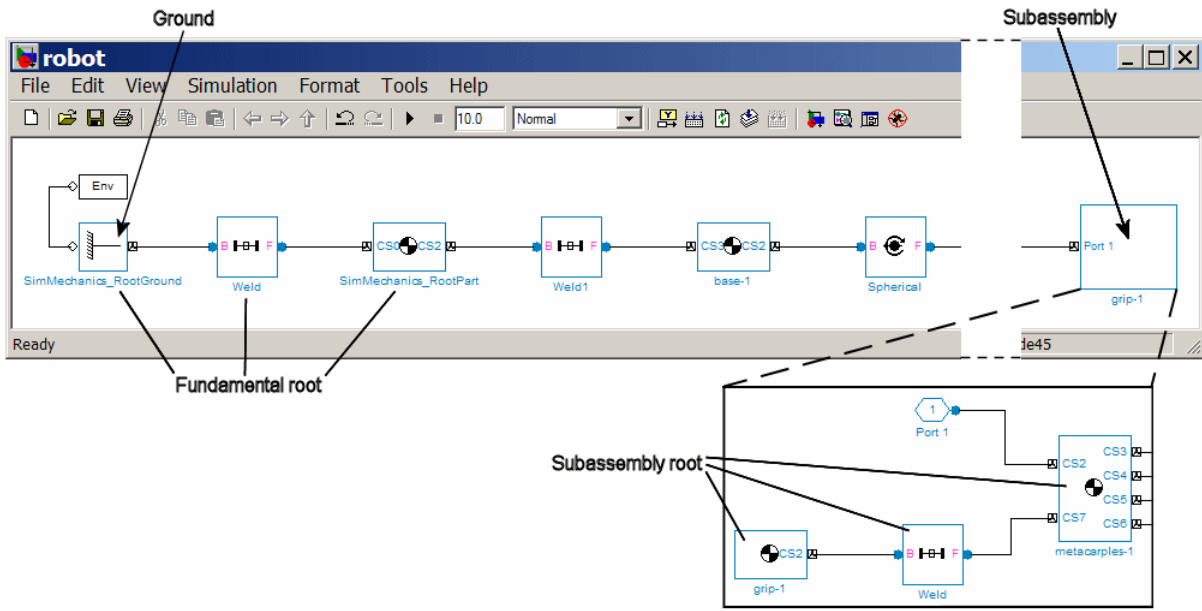

World Coordinate System and the CAD Assembly Origin

A generated model has one Ground. The origin of this Ground is the origin of the World coordinate system and represents the original CAD assembly origin.

SimMechanics Visualization and STL Body Geometry Files

Each body in a generated SimMechanics model, apart from the ground and root bodies, is configured to reproduce the body geometry and color of its original CAD assembly body. If the needed STL files were created upon export and are referenced by the generated model, the custom body geometries are visualized. Each Body references its own STL file.

Caution In order for custom visualization to work, this STL file must be either:

- On your MATLAB path.
- In your MATLAB present working folder.
- Specified with complete path in the Body dialog.

Otherwise, visualization reverts to the default body geometry.

For More About CAD Assemblies

Fully understanding the structure of a generated model requires understanding the original system in its CAD representation. Refer to your originating CAD assembly, CAD platform and associated documentation, and the SimMechanics Link documentation.

Nondefault Features in Generated Models

The importer controls allow generation of models with nondefault appearance and structure. Optional, nondefault coordinate systems can enhance the fidelity and usefulness of your models.

See “Controlling New Model Import” on page 4-8 and the `mech_import` function reference page.

Nondefault Appearance and Layout of Generated Models

The following table summarizes the default and possible nondefault appearance options of a newly imported model.

Default Appearance and Layout Options	Nondefault Appearance and Layout Options
Short Joint block names based on joint type	Potentially long Joint block names based on model hierarchy
Block names that are potentially overlapping	Block names that do not overlap
Block diagrams first oriented horizontally from left to right, then vertically from top to bottom	Block diagrams first oriented vertically from top to bottom, then horizontally from left to right

Nondefault Hierarchy and Organization of Generated Models

The following table summarizes the default and nondefault hierarchy and organization options of a newly imported model.

Aspect of Hierarchy & Organization	Default Hierarchy & Organization	Nondefault Option A	Nondefault Option B
Location of non-Weld Joints	At the subsystem level corresponding to the subassembly level in the original CAD assembly	At the highest level of the model or subsystem being imported	Same as default
Grouping of Bodies	Ungrouped and located individually at the	Grouped into their own subsystem within the	Same as nondefault hierarchy A

Aspect of Hierarchy & Organization	Default Hierarchy & Organization	Nondefault Option A	Nondefault Option B
rigidly connected by Welds	subsystem level corresponding to the subassembly level in the original CAD assembly	subsystem corresponding to the subassembly level in the original CAD assembly	

Coordinate Systems in Generated Models

In addition to the paired coordinate systems automatically generated for Body–Joint connections, a generated model can contain other coordinate systems:

- Imported versions of reference coordinate systems in the original CAD assembly that are not, in general, associated with CAD constraints. See “Inserting Reference Coordinate Systems into Assemblies Before Export” on page 4-41. Upon import, before manual modifications to the model, these Body coordinate systems are not connected to other blocks.
- Coordinate systems manually added to the generated model after import. See “Adding More Coordinate Systems” on page 4-17 .

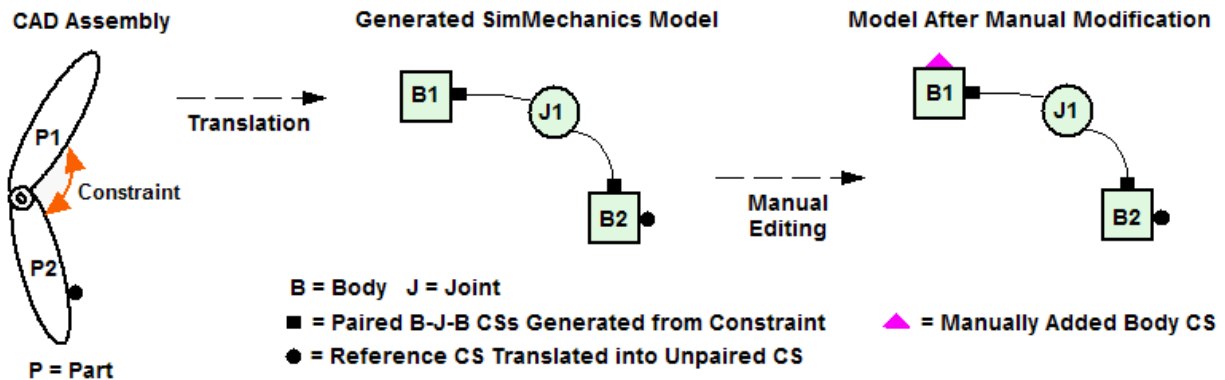

Coordinate Systems: Automatically Generated, Inserted Before Export, and Manually Added After Import

Manually Modifying and Extending Generated Models After Import

A SimMechanics model satisfying full modeling requirements typically contains other blocks beyond those generated by import. These blocks can include Constraints, Drivers,

Sensors, and Actuators (from the SimMechanics block library), as well as blocks from Simulink, such as Scopes. You manually insert and connect these additional blocks in your generated model.

Tip When you first generate a model from Physical Modeling XML, you might want to save this original CAD-based model before you create later versions by eliminating unnecessary blocks and adding new ones.

Deleting Unnecessary Blocks

The constraint-to-joint mapping creates whatever blocks are needed to correctly isolate the degrees of freedom (DoFs). In some models, certain generated blocks are not needed for simulation. You can delete these unnecessary blocks to simplify your model without affecting its dynamics, as long as you reconnect the remaining blocks properly.

In particular, you can simplify the fundamental root, Ground – Root Weld – Root Body, in certain cases. (The same holds for subassembly roots. However, the corresponding subsystem's Root Body takes the place of Ground, and the subsystem's Fixed Body plays the role of Root Body.)

- If the Root Body is connected to the rest of the block diagram by a single Joint, you can delete the Root Weld – Root Body blocks and reconnect the Joint directly to Ground.
- If the Root Body is connected to the rest of the block diagram by multiple Joints, you cannot delete the Root Weld – Root Body sequence because a Ground can connect to only one Joint, and the generated model contains only one Ground. You have two alternatives in this case:
 - Determine where the Root Body coordinate systems (CSs) are. Delete the Root Weld – Root Body sequence. Then manually add more Grounds at the spatial points representing each of the deleted Root Body CS origins. Reconnect each Joint to its corresponding Ground at the correct spatial point.
 - Leave the Root Weld – Root Body sequence as it is.

Regrouping, Reducing, and Eliminating Welds

Not all Welds are redundant. Some Welds are needed to connect a Body that otherwise would be isolated from the rest of the model. Such Welds represent rigid connections between distinct assembly parts.

- If you want to group Bodies rigidly connected by Welds into their own subsystems, use the model hierarchy simplification controls in the **Advanced Options** tab of the Import Physical Modeling XML dialog box or `mech_import` function.
- If you want to reduce or eliminate such Welds, return to your original assembly and reexport it with rigid subassemblies. See the SimMechanics Link documentation.

Adding More Coordinate Systems

In addition to the automatically generated pairs of coordinate systems that connect Joints representing CAD constraints, you can also add your own coordinate systems to Bodies, after import. If you want to add Constraint, Driver, Actuator, or Sensor blocks to a generated model, and connect these blocks to one or more of the Bodies, you need extra Body coordinate systems as connection points.

These sections describe how to add Body coordinate systems to a Body:

- “Modeling Grounds and Bodies”
- “Working with Body Coordinate Systems”

Reference Coordinate Systems in the Original Assembly

You can also insert reference coordinate systems, in general not associated with constraints, in the original assembly before export. You might find positioning and orienting such coordinate systems easier in the CAD environment. Translation preserves these coordinate systems, which appear in the generated model in addition to the coordinate systems pairs connecting Joints and Bodies.

For more information, see “Inserting Reference Coordinate Systems into Assemblies Before Export” on page 4-41.

Constraining and Driving Degrees of Freedom

Constraints reduce the number of independent degrees of freedom in a mechanical system by preventing certain movements. Drivers affect DoFs, not by eliminating them completely, but by forcing their motions to follow an external time-dependent signal. A constrained or driven DoF is not free to respond to forces and torques independently.

These sections discuss how to add constraints and drivers to your model:

- “Constraining and Driving Degrees of Freedom”
- “Actuating a Driver”

Note: You insert these constraints into the SimMechanics model as blocks. They act in addition to the part constraints in the original CAD assembly.

Actuating Bodies and Joints with Motions and Forces

You can actuate bodies and joints in your SimMechanics models with external forces and motions and set up internal forces between bodies. You can also vary the mass or inertia (or both) of a body in time. Consult these sections for more details:

- “Actuating a Body”
- “Varying a Body's Mass and Inertia Tensor”
- “Actuating a Joint”
- “Adding Internal Forces”

Setting the Model's Initial Conditions

When you import a CAD assembly into the SimMechanics environment, the XML file determines the initial geometric configuration of the model's bodies. By default, the initial velocities of the bodies are zero, and the model is in .

If you want to change the initial positions and/or velocities of the bodies in your model to be different from the CAD-determined configuration, you need to add initial condition actuators, as discussed in “Specifying Initial Positions and Velocities”.

Sensing Forces and Motions

To detect the motions of bodies and joints and measure the forces acting on or through them, you can add sensors to your model. See “Sensing Motions and Forces”.

Satisfying SimMechanics Model Validity Requirements

You can find the general instructions for building valid SimMechanics models in these sections:

- “Representing Machines with Models”
- “Validating Mechanical Models”

Changing Custom Body Visualization Geometries and Colors

When it generates the Body blocks in a model (except for Root Bodies), the SimMechanics importer automatically customizes the body geometries for visualization by referencing

the STL files associated with the CAD assembly export. It also automatically customizes the body colors to match the original CAD part colors, which are captured by the exported XML file.

You can manually reset the custom visualization on one or more of these Bodies, changing body shape, color, or both. See the Body block reference page and “About Custom SimMechanics Visualization”.

Model Update with Physical Modeling XML

In this section...
“About Model Update and Mechanical Import” on page 4-20
“Updating a Machine in a Generated Model with Revisions” on page 4-23
“Adding a New Machine to a Generated Model” on page 4-25
“Replacing Generated Model or Subsystem Contents with a New Machine” on page 4-27

About Model Update and Mechanical Import

Note: For the steps to generate a model by importing, see “Generating New Models from Physical Modeling XML”.

For complete information on exporting Physical Modeling XML, see the SimMechanics Link documentation.

The `mech_import` command and import dialog let you update models previously generated from Physical Modeling XML. After revising the model's originating CAD assembly, you export a new XML file representing the changed system. You can import this new XML file to generate a new SimMechanics model, although you would have to repeat on the new model whatever manual, post-translation work you did on the old model.

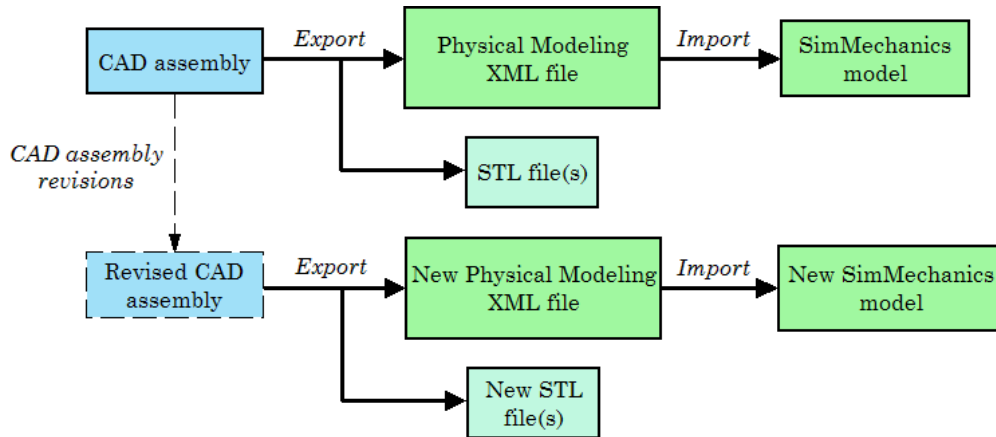

Translating a Revised CAD Assembly by Generating a New SimMechanics Model

But you can also *update-import*: import the new XML file to update the existing model. Update-importing allows you to retain whatever manual, post-translation work you did on the old model. You also keep any unchanged CAD-related features of the model.

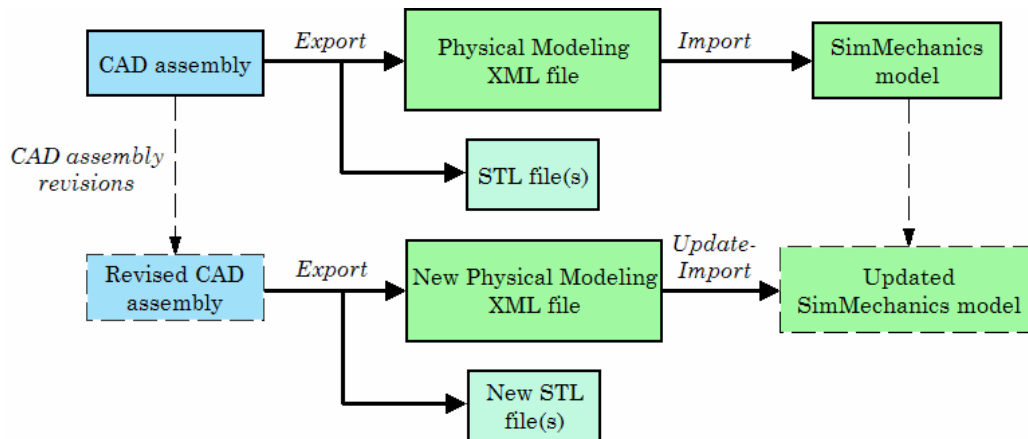

Translating a Revised CAD Assembly by Updating an Existing Generated SimMechanics Model

Updating by Subsystem, Machine, and Model

Update-import encompasses three distinct ways of revising a generated model with revised assembly information. It revises by blocks within a machine, an entire machine, an entire subsystem, or the entire model.

- Updating an existing machine in the model, which might include adding new blocks to the machine
- Adding a new machine to the model
- Replacing model or subsystem contents with entirely new contents

Note: Update-import respects the model-machine-subsystem hierarchy of an existing model. If you want to change this existing model hierarchy, you must manually edit the generated model or generate a new model from your CAD assembly or XML file.

Requirements for Updating a Previously Generated Model by Importing Physical Modeling XML

This section assumes that you have the SimMechanics product installed locally or remotely, and that you have:

- The XML file representing a revised CAD assembly
- The generated SimMechanics model you want to update
- Optionally, the STL body geometry files associated with the CAD assembly

To update-import the model, you do not need the CAD platform or assembly from which the XML file was exported. You also do not need the SimMechanics Link utility.

Inheritance Relationships Between Assemblies and Models

See “Controlling Model Update at the Block Level” for a complete explanation of the inherited structure and identity shared by assemblies and models based on them.

Controlling the Automatic Backup of Updated Models

Updating an existing generated model erases previous model information. But, by default, the importer saves a copy of the previous version of the model through automatic backup. You can control this automatic backup through the options in the `mech_import` command or the import dialog. You can choose any one of these possibilities

- Back up your previous model version in the same folder as the new version. This is the default.
- Back up your previous model version in a different folder, which you specify.
- Do not back up your previous model version at all.

You can set these options through the **Backup mode** pull-down menu in the **Backup** area of the **Advanced Options** tab of the import dialog.

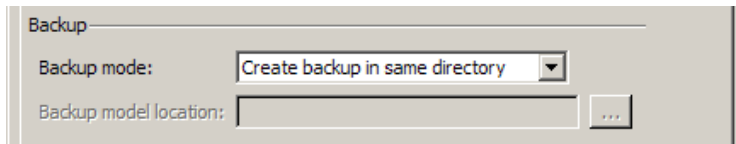

Revisions to STL Body Geometry Files

Any revisions to an existing CAD assembly are reflected in the new set of exported STL files that replace the old set of STL files from the earlier version of that assembly. Each updated Body block continues to reference its corresponding STL file.

Updating a Machine in a Generated Model with Revisions

Revising a SimMechanics model previously generated from a CAD assembly means that the importer translates changes to assembly part and constraint properties into changes in Body and Joint properties. Depending on the nature of the assembly changes, new blocks and connections can be added as well, and individual blocks can be replaced. Property changes include changes to body mass properties and to body and grounded coordinate system (CS) properties. Revising changes or extends only a single machine in the model with revisions.

You start such an update-import with either

- The `mech_import` command; see the command reference page.
- The import dialog. On the **Import** tab, under **Import mode**, select **Update existing model**. After configuring and applying the settings, click **OK**.

Using the two fields at the bottom of this tab, you can enter a nondefault model name, and possibly a subsystem name, into which to import the revisions. The default is for the importer to take the model and subsystem names from the XML file. In either

case, the specified model, and possibly subsystem, must exist for the update-import to succeed.

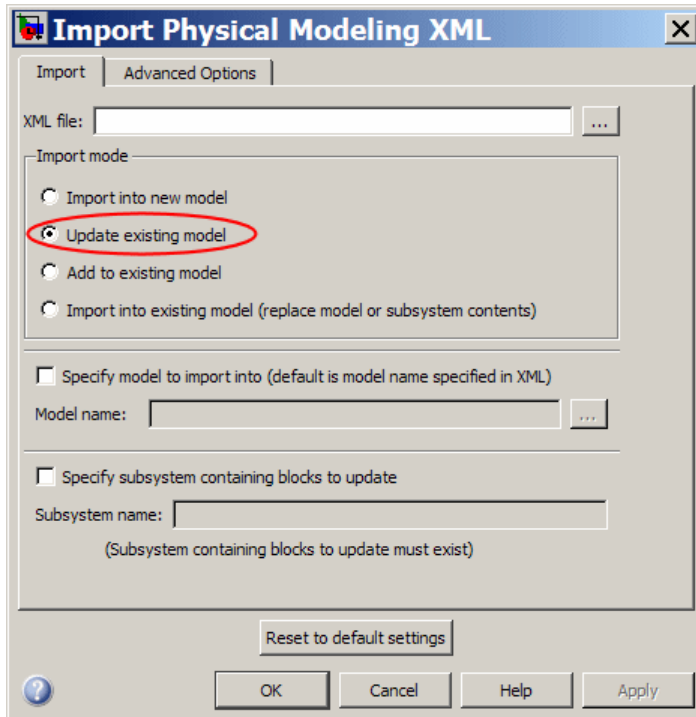

Controlling the Appearance and Hierarchy of an Updated Machine

An update-import can change the appearance of a generated machine. In both the `mech_import` command and on the **Advanced Options** tab of the import dialog, you can control how these changes occur. These controls are similar to the controls available for importing a new model. See “Controlling New Model Import” on page 4-8.

- In the **Layout** area, you can require that the importer label new Joint blocks with short names based on the Joint type.
- In the **Update** area, you can require the importer to:
 - Find the best spatial arrangement of the blocks.

- Import new Joint blocks at the highest level, depending on whether you are importing into a model or a subsystem, and regardless of where the corresponding degrees of freedom occur in the original assembly.

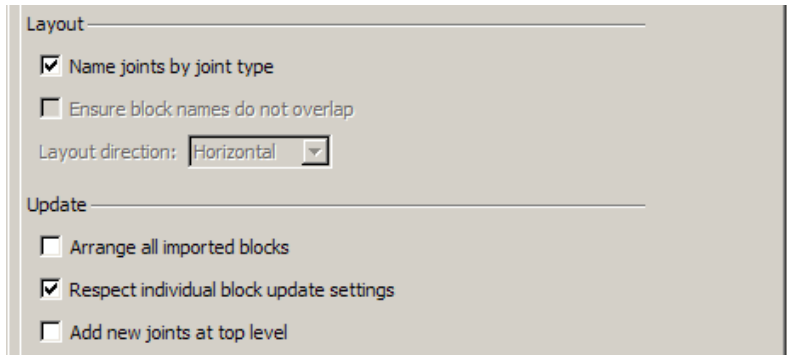

Controlling How Update-Import Changes Individual Blocks

In the **Update** area, you can use **Respect individual block update settings** to control on a block-by-block basis how the importer changes blocks and their connections with updates. Proper control of individual block updating requires understanding how a generated model “remembers” its originating assembly. See “Controlling Model Update at the Block Level” on page 4-29.

Adding a New Machine to a Generated Model

Adding a new machine to a SimMechanics model previously generated from a CAD assembly means that the importer translates a completely new assembly into additional Bodies, Joints, and subsystems. Such changes do not include updating existing machines in the model.

You start such an update-import with either:

- The `mech_import` command; see the command reference page.
- The import dialog. On the **Import** tab, under **Import mode**, select **Add to existing model**. After configuring and applying the settings, click **OK**.

Using the two fields at the bottom of this tab, you can enter a nondefault model name, and possibly a subsystem name, into which to import the revisions. The default is for

the importer to take the model and subsystem names from the XML file. In either case, the specified model, and possibly subsystem, must exist for the update-import to succeed.

If you are adding a new subsystem, select the **Create new subsystem if it does not exist** check box.

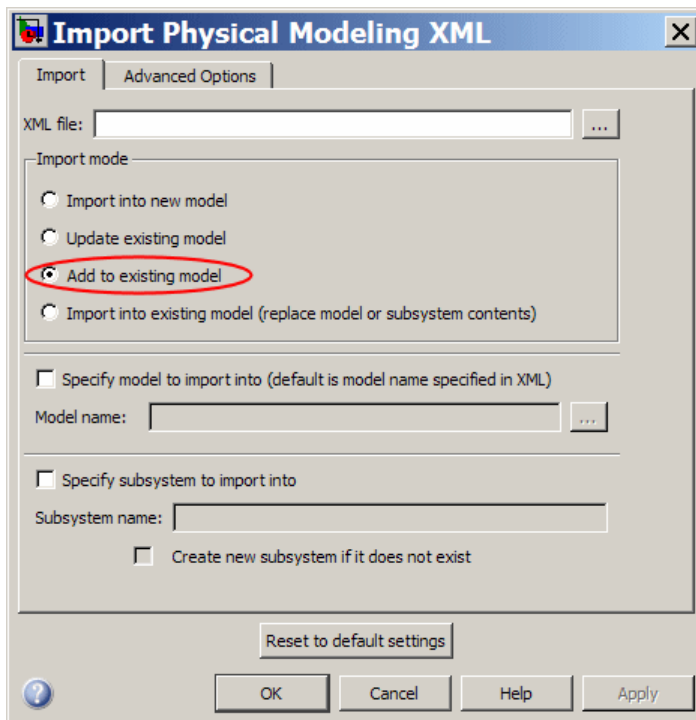

Controlling the Appearance and Hierarchy of an Updated Model with an Added Machine

An update-import with an additional machine changes the appearance and hierarchy of a model. In both the `mech_import` command and the **Layout** and **Model Simplification** areas of the **Advanced Options** tab of the import dialog, you can control how these additions occur, in the same way as if you were generating a new model. See “Controlling New Model Import” on page 4-8.

Replacing Generated Model or Subsystem Contents with a New Machine

Replacing model and subsystem contents in a SimMechanics model previously generated from a CAD assembly means that the importer either:

- Completely erases the contents of the model at the top level and replaces these contents with an entirely new machine.
- Completely erases the contents of a subsystem and replaces these contents with an entirely new subsystem.

Warning Update-importing by replacement deletes the previous contents of the model or subsystem. If you need to retrieve the old contents, use the model's backup copy. See “Controlling the Automatic Backup of Updated Models”.

You start such an update-import with either:

- The `mech_import` command; see the command reference page.
- The import dialog. On the **Import** tab, under **Import mode**, select **Import into existing model (replace model or subsystem contents)**. After configuring and applying the settings, click **OK**.

Using the two fields at the bottom of this tab, you can enter a nondefault model name, and possibly a subsystem name, into which to import the revisions. The default is for the importer to take the model and subsystem names from the XML file. In either case, the specified model, and possibly subsystem, must exist for the update-import to succeed.

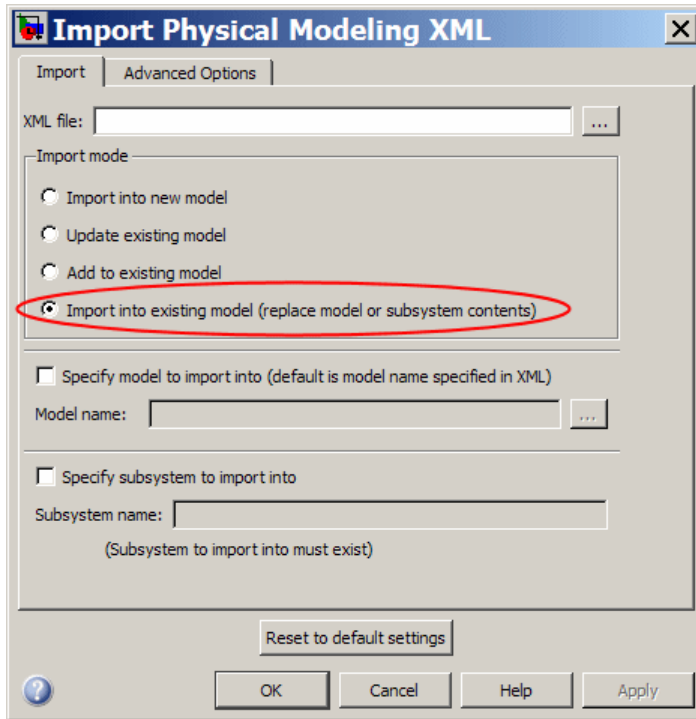

Controlling the Appearance and Hierarchy of an Updated Model or Subsystem with Replaced Contents

An update-import with completely replaced contents changes the appearance and hierarchy of a generated model or subsystem. In both the `mech_import` command and the **Layout** and **Model Simplification** areas of the **Advanced Options** tab of the import dialog, you can control how these additions occur, in the same way as if you were generating a new model. See “Controlling New Model Import” on page 4-8.

Controlling Model Update at the Block Level

In this section...

“Associativity and Updating” on page 4-29

“Working with Associativity in Common Updating Situations” on page 4-31

“Controlling How Update-Import Changes Individual Blocks and Connections” on page 4-34

“Associativity in an Updating Sequence Example” on page 4-37

Associativity and Updating

To update an existing generated SimMechanics model with changes to its original external definition (a CAD assembly, for example), the intermediate Physical Modeling XML file and the model itself must retain information about the identities of at least some of its components. This section explains this “identity memory” or *associativity*.

What Is Associativity?

Associativity is a key concept for understanding the relationship between CAD assemblies and SimMechanics models based on them, and the export and updating process that defines SimMechanics models from CAD assemblies.

Associativity Between CAD Assemblies and SimMechanics Models

Associativity is a persistent (session-independent) parallel relationship among certain components of a CAD assembly, Physical Modeling XML files exported from it, and SimMechanics models generated from the XML files.

This relationship preserves the identities and parallelisms of certain CAD components and the corresponding imported components of the SimMechanics model. The SimMechanics Link exporter defines these unique identities from the CAD assembly components and embeds them in the exported Physical Modeling XML file. SimMechanics models generated from the XML file in turn retain these identities.

You actualize associativity when you generate a SimMechanics model from a CAD assembly. Associativity is a mapping between parts, constraints, and subassemblies in a CAD assembly and the corresponding Body and Joint blocks, coordinate systems, and subsystems in the SimMechanics model generated from that CAD assembly. It uniquely

captures the identities of these CAD components, their corresponding blocks, and their topology (how they are connected to one another).

Associativity is not completely symmetric between the CAD and SimMechanics worlds, because the translation process moves in one direction only, from CAD assembly to generated SimMechanics model.

When and Why You Need Associativity

Associativity is required for updating a generated SimMechanics model when its originating CAD assembly has been changed.

How Associativity Is Implemented

When you use the SimMechanics Link exporter to create a Physical Modeling XML file from a CAD assembly, these components receive unique XML identifiers. When you use the SimMechanics importer to generate a SimMechanics model from the XML file, the identifiers are preserved in the corresponding SimMechanics model features.

Parallel Identities Between CAD Assembly and SimMechanics Model Components Captured by Associativity

CAD Assembly Components	Corresponding Imported SimMechanics Model Components
Parts and grounds	Body and Ground blocks
Constraints between parts (allowed motions)	Joint blocks
Constraints between parts (positions and orientations)	Paired coordinate systems attached to Joints
Reference coordinate systems	Body coordinate systems unattached after import
Subassembly hierarchy	Subsystem hierarchy

Changing Assemblies, Generated Models, and Their Associativity

The associativity of CAD assembly and generated SimMechanics model is open, modifiable, and extensible. As long as a generated SimMechanics model retains at least one associated imported component, this model retains some associativity with its originating CAD assembly.

Preserving associativity

You preserve the original associativity if you do not remove or reconnect associated components in either the CAD assembly or the SimMechanics model.

Changing the properties of an associated component, without removing or reconnecting it, both uses and preserves associativity.

Extending associativity

You extend the original associativity if you add new, associable components to the CAD assembly, export the assembly, and update-import the generated SimMechanics model. The new components generated in the updated SimMechanics model are associated with the new components of the CAD assembly.

Modifying associativity

You modify the original associativity if you remove or reconnect one or more associated components in the SimMechanics *model*.

- The associativity of the removed or reconnected associated components is destroyed.
- The associativity of the other associated components, and of the SimMechanics model as a whole, remains intact.
- You recreate the original associativity of the removed or reconnected components in the SimMechanics model if you reimport the unchanged components from the CAD assembly.

You can prevent this reimportation of the original CAD assembly components and overwriting of your manual changes to a SimMechanics model, depending on your import settings. See “Working with Associativity in Common Updating Situations”.

Replacing associativity

You replace the original associativity if you remove or reconnect one or more associated components in the CAD *assembly*.

Once you export the CAD assembly and update-import the SimMechanics model, the associativity of the removed or reconnected components is destroyed. In this case, the component is either connected in a new way, with a new associativity, or it is removed altogether.

Working with Associativity in Common Updating Situations

The unique parallel identities created by associativity allow you to revise and expand CAD assemblies, then export the changed CAD assemblies and update existing SimMechanics models based on them. While you can also create entirely new

SimMechanics models from the updated XML, associativity saves the effort invested in editing and testing by reusing existing SimMechanics models.

The following translation cases cover the basic possibilities. You can combine some of them into more complex, compound cases. For example, you can change a CAD assembly by both revising existing component properties and adding new components.

You can also modify the import process by preventing or allowing certain automatic block and block connection changes. See “Controlling How Update-Import Changes Individual Blocks and Connections”.

Exporting a CAD Assembly and Generating a SimMechanics Model for the First Time

During CAD export, SimMechanics Link assigns a unique XML identifier to each CAD component. For a table summarizing the different CAD components, see “How Associativity Is Implemented”.

When you import the XML file and generate a SimMechanics model from it, the corresponding model components listed in the table's second column receive these parallel identities.

Updating a Generated SimMechanics Model by Modifying CAD Assembly Properties

If you modify a CAD assembly and export a new Physical Modeling XML file from it, updating the model with the modifications allows you to reuse an existing SimMechanics model that was previously translated from the same assembly.

You modify a CAD assembly when you change the properties of its components without changing their identity. For a table of CAD assembly components you can modify, see “How Associativity Is Implemented”.

You update a generated SimMechanics model when you import the Physical Modeling XML file for the modified CAD assembly. The updated model reflects the new component properties in the modified assembly.

Associativity identifies the components in the existing generated SimMechanics model so that the importer can update their properties.

Tip You can prevent the SimMechanics importer from updating one or more particular associated blocks when you update-import a generated SimMechanics model. See “Controlling How Update-Import Changes Individual Blocks and Connections”.

Updating a Generated SimMechanics Model by Extending the CAD Assembly

If you add more components to a CAD assembly and export a new Physical Modeling XML file from it, updating the model with the extensions allows you to reuse an existing SimMechanics model previously translated from the same CAD assembly.

You extend a CAD assembly when you add one or more components to it. For a table of CAD assembly components you can add, see “How Associativity Is Implemented”.

You update a generated SimMechanics model when you import the Physical Modeling XML file for the extended CAD assembly. The updated model contains new blocks representing the new components in the extended assembly. Blocks representing original CAD components remain unchanged.

Associativity identifies the original components in the existing generated SimMechanics model so that the importer does not change them while adding the new associated components.

Modifying a Generated SimMechanics Model Associated with a CAD Assembly, Then Updating Its Associated Components

You can also manually add nonassociated components to an existing SimMechanics model previously generated from a CAD assembly, separately revise the assembly, then retranslate the assembly by update-importing the SimMechanics model with the revisions.

- The associated SimMechanics model components are updated with the CAD assembly revisions.
- The nonassociated SimMechanics model components are not unchanged.
- If the nonassociated SimMechanics model components are connected in the original model to associated blocks, they might become disconnected after update-import.
 - Nonassociated model components can include Constraints, Drivers, Actuators, and Sensors that you manually added and connected to associated, imported Bodies and Joints.
 - Nonassociated model components can also include Bodies and Joints added manually after you generated the original SimMechanics model. These Bodies and Joints were not import-generated and therefore cannot be associated.

Tip You can prevent the SimMechanics importer from updating associated blocks or disconnecting nonassociated blocks from updated associated blocks when you update-

import a generated SimMechanics model. See “Preserving and Breaking Connectivity of Nonassociated Blocks to Updated Associated Blocks”.

Replacing Associated Joints with Nonassociated Joints in a Generated SimMechanics Model, Then Updating the Model

You can manually delete an associated imported Joint and replace it with a nonassociated Joint. This option is an important case of modifying and updating a generated SimMechanics model.

- 1 Delete the associated imported Joint.
- 2 Add a replacement Joint manually. This Joint is not associated with the original CAD assembly, because it was not imported.

However, the two Bodies on either side of the Joint and to which it is connected are still associated, unless you also replace them. Thus the replacement Joint is a nonassociated block connected to two associated blocks.

- 3 Update-import the modified SimMechanics model with changes to the originating CAD assembly. Because it is not associated, the replacement Joint is not changed by the update-import.
- 4 Fix any broken connections of the replacement Joint to the associated Bodies, depending on the nature of the changes to the originating CAD assembly.
 - You can allow the update-import to break these connections.
 - But you can also require the update-import to preserve these connections. See “Preserving and Breaking Connectivity of Nonassociated Blocks to Updated Associated Blocks”.

If you replace the associated Bodies on either side of the Joint as well, then all three blocks are now nonassociated. The update-import cannot change them or any connections among them.

Controlling How Update-Import Changes Individual Blocks and Connections

You can modify how the update-import process changes the updated model.

Enabling and Disabling Automatic Update of Individual Associated Blocks

If you want to prevent the update-import process from updating or removing particular blocks in a generated model, you can disable the updating or removal for individual blocks. Doing this does not erase any associativity information from these blocks, and you can reenable automatic updating as long as the block exists in the model.

To enable automatic updating for an individual associated block:

- 1 Right-click the block and select the **SimMechanics** menu item.
- 2 Clear **Retain without updating properties**. This is the default.

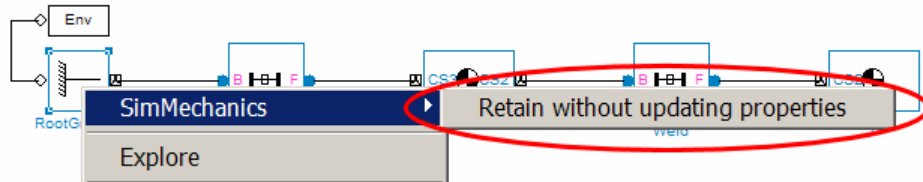

To disable automatic updating for an individual associated block:

- 1 Right-click the block and select the **SimMechanics** menu item.
- 2 Select **Retain without updating properties**.

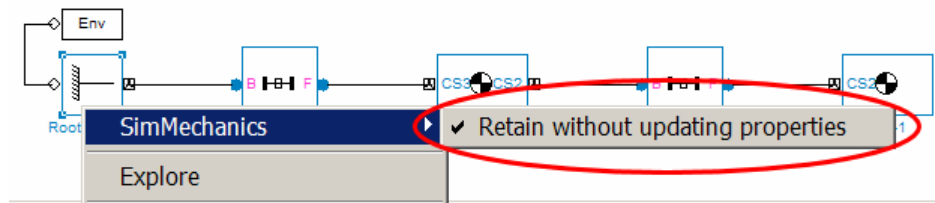

Note: The right-click submenu item is available only on associated blocks. The default for **Retain without updating properties** is cleared. That is, the default is that automatic block updating is enabled.

Respecting and Overriding Associated Block Update Settings During Model Update-Import

You can override individual associated block update settings for the model update as a whole.

In the import dialog, you can specify whether the update-import respects or overrides these individual block settings on the **Advanced Options** tab. (The `mech_import` command allows you to set an equivalent option as a command input.)

- To require that the update-import respect the individual associated block update settings, select the **Respect individual block update settings** check box. This is the default.

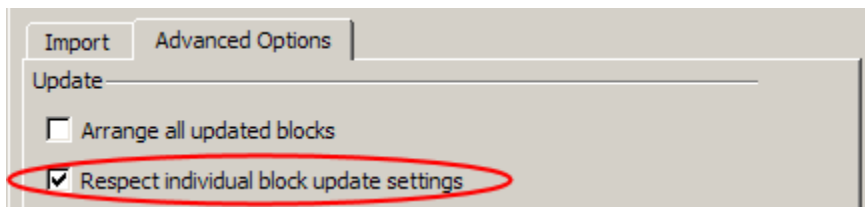

- To override the individual associated block update settings, clear the **Respect individual block update settings** check box.

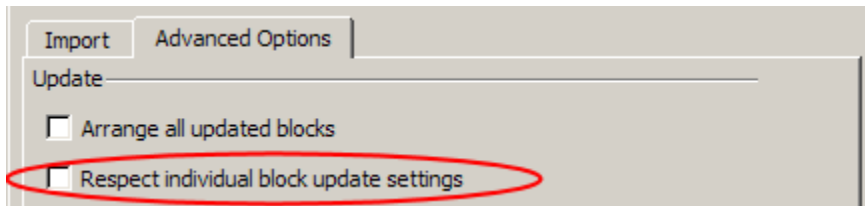

Preserving and Breaking Connectivity of Nonassociated Blocks to Updated Associated Blocks

If you want the update-import to preserve the connections of individual nonassociated blocks to associated blocks, you can enable connection preservation for individual blocks. You can also allow the update-import to break such connections. Allowing connection breaking does not remove the nonassociated block. You can reconnect it manually and reenabling connection preservation again as long as the block exists in the model.

To always preserve the connection of an individual nonassociated block from an updated associated block:

- 1 Right-click the nonassociated block and select the **SimMechanics** menu item.
- 2 Select **Retain connectivity to imported blocks**. This is the default.

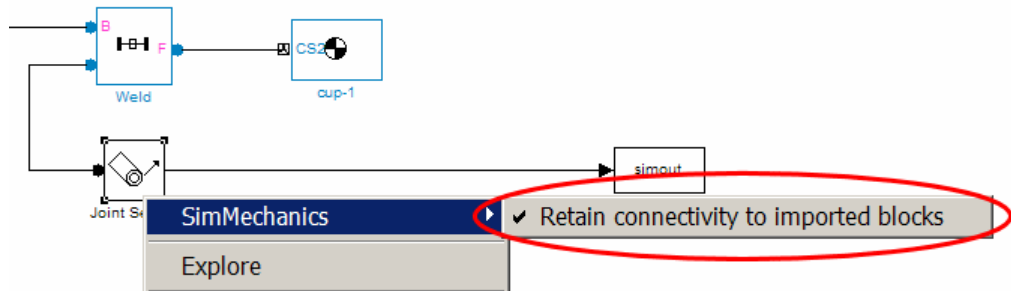

To allow automatic disconnection of an individual nonassociated block from an updated associated block:

- 1 Right-click the nonassociated block and select the **SimMechanics** menu item.
- 2 Clear **Retain connectivity to imported blocks**.

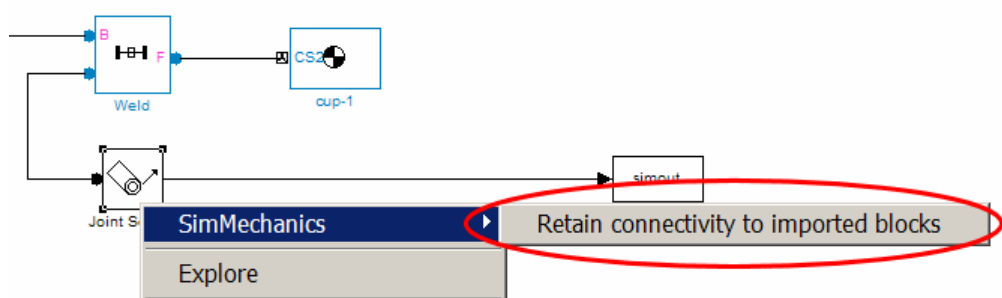

Note: The right-click submenu item is available only on nonassociated blocks connected to associated imported blocks. The default for **Retain connectivity to imported blocks** is selected. That is, the default is that automatic updating preserves the nonassociated block's connection to associated blocks.

Associativity in an Updating Sequence Example

This example shows how associativity works and how you can use it in a simple three-body mechanical system translated from a CAD assembly to a SimMechanics model.

The machine consists of three bodies connected in a chain. The first and second bodies are constrained with one type of allowed motion. The second and third bodies are constrained with another type of allowed motion.

Translating the Assembly and Generating the Model for the First Time

The initial translation from the CAD assembly results in a SimMechanics model with three bodies (B1, B2, B3) connected in a chain by two joints (J1, J2). These associated model components are the Body and Joint blocks and the Body Coordinate Systems (CSs) that connect the Bodies through the Joints.

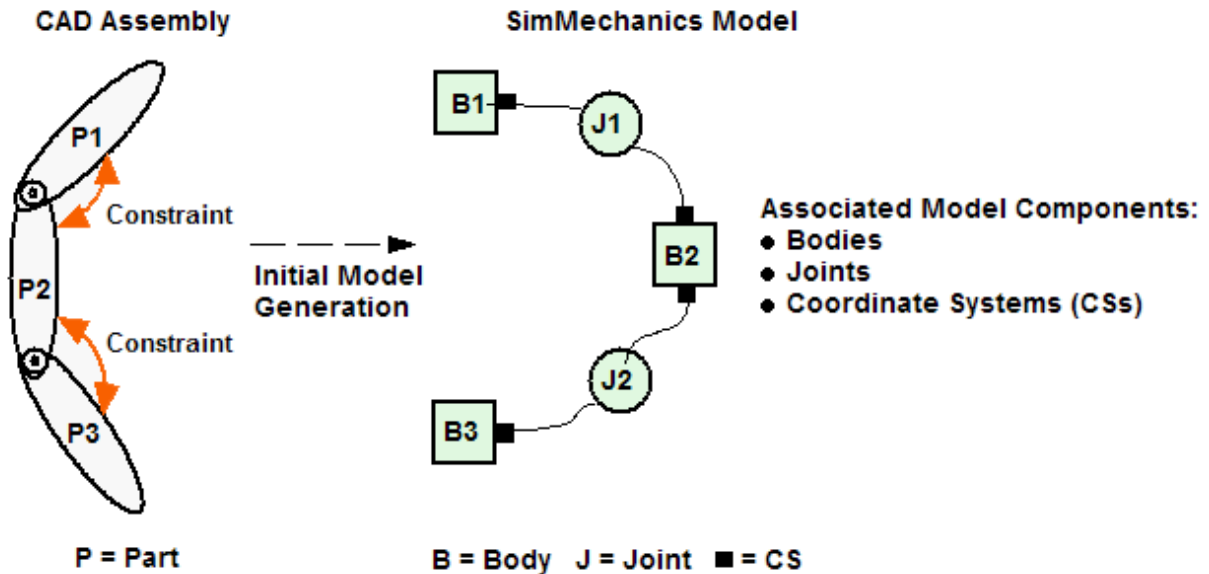

Revising an Assembly Body, Manually Adding Nonassociated Sensors in the Model, and Updating the Model from the Assembly

The next step is to revise the assembly by changing some properties of one of the assembly parts (P2). At the same time, you add two new, nonassociated components to the generated model: a Joint Sensor (JS) and a Body Sensor (BS).

You then update-import the model from the revised assembly. The body properties of B2 are updated. Assuming you keep the default settings, the connections of the nonassociated Joint and Body Sensors to J1 and B3, respectively, are retained.

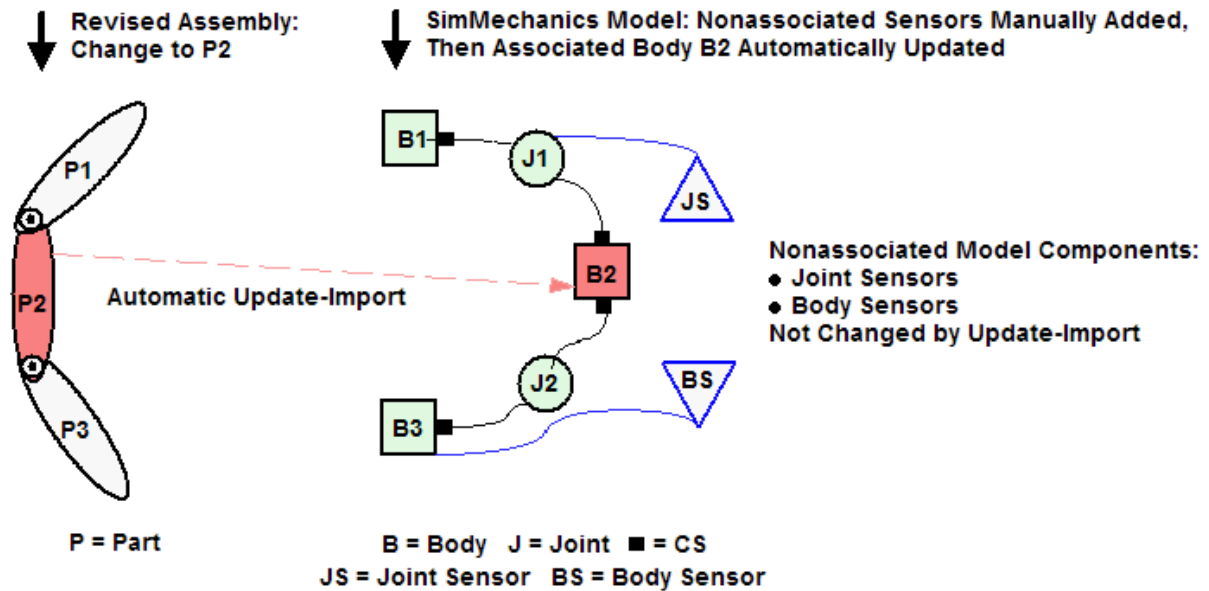

Manually Replacing an Associated Model Joint and Updating the Model from the Assembly: Update Options

The last step in the example is to manually replace one of the model joints (J2) with a new, nonassociated Joint block (J3). If you update-import the model from the assembly now, you must choose how to update the replaced joint J3:

- You can override the manual joint replacement.

The old joint J2 is reimported and re-replaces the manually inserted joint J3. This is default setting on SimMechanics blocks.

- You can require that the manual changes be retained.

The newly added joint J3 is retained. This choice requires you to change the default setting on the relevant SimMechanics blocks.

The import default is to respect the individual block settings in any case, although you can change that as well.

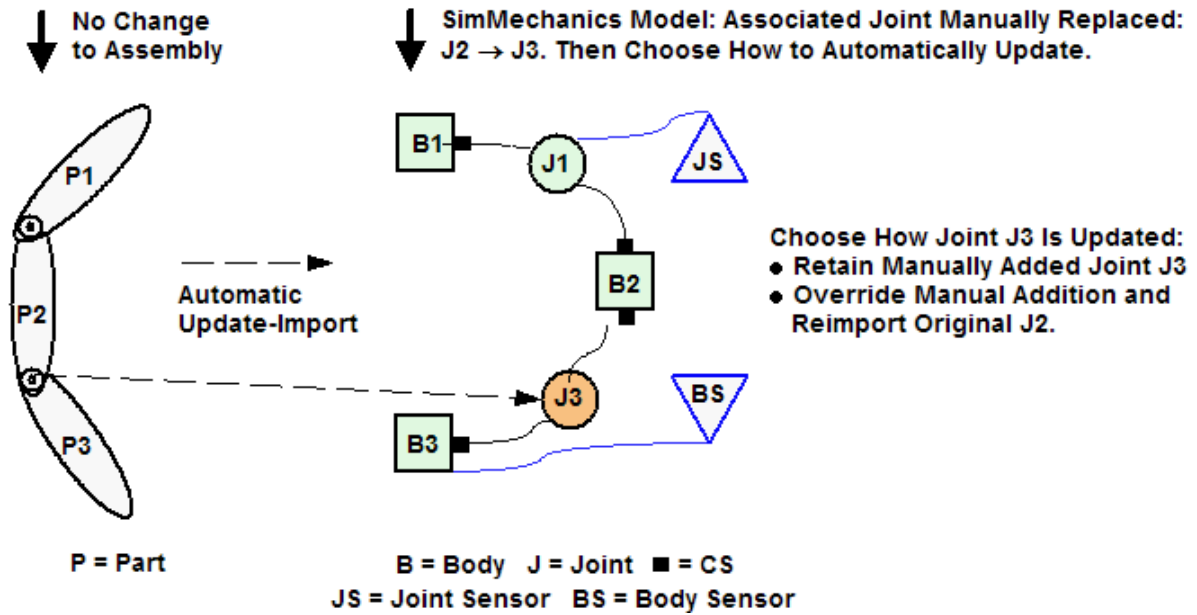

Troubleshooting Imported and Updated Models

In this section...

- “Best Practices for Creating and Exporting Assemblies” on page 4-41
- “Inserting Reference Coordinate Systems into Assemblies Before Export” on page 4-41
- “Controlling Mechanical Import to Assist Troubleshooting” on page 4-42
- “Troubleshooting Errors During Model Generation” on page 4-42
- “Troubleshooting Errors During Model Update” on page 4-43
- “Troubleshooting Model Simulation Errors” on page 4-43
- “Troubleshooting SimMechanics and Simulink Problems” on page 4-43

If your CAD assembly was not constructed or exported properly, you might encounter problems in your generated SimMechanics model.

Best Practices for Creating and Exporting Assemblies

The SimMechanics Link documentation presents instructions and tips on these topics:

- Constructing a CAD assembly specifically for SimMechanics
- “Fixing” subassembly parts and subassembly roots
- Exporting a CAD assembly
- Identifying and fixing export errors

Inserting Reference Coordinate Systems into Assemblies Before Export

Translation might not place Body coordinate systems where you need them in the imported model, to attach Joint, Constraint, Driver, Actuator, or Sensor blocks. If so, insert reference coordinate systems into the CAD assembly at the appropriate positions and orientations and re-export the assembly into an XML file for import. These pre-export reference coordinate systems appear on the corresponding Body blocks after import.

For more information, see:

- “Coordinate Systems in Generated Models” on page 4-15.

- “Adding More Coordinate Systems” on page 4-17.

Note: Inserting and optionally exporting reference coordinate systems is not supported for all CAD platforms supported by SimMechanics Link software.

Controlling Mechanical Import to Assist Troubleshooting

Both the Import Physical Modeling XML dialog box and the `mech_import` function have model generation controls that can assist you in isolating errors in a newly imported model. You can:

- Make the Joint blocks, the Body blocks rigidly connected by Welds, or both, in your model easier to locate by using the model hierarchy simplification options.
- Make the Joint and other blocks easier to locate and identify by changing the model layout options.

Troubleshooting Errors During Model Generation

Errors in the Physical Modeling XML file appear as warnings at the MATLAB command line during model generation.

Identifying and Fixing Joint Translation Errors

Warnings arise from CAD constraint translation errors encountered when the XML file was originally exported. Such errors occur when the translator fails to map one or more CAD constraints, which restrict the degrees of freedom between parts, into their corresponding SimMechanics joints. The exporter warns you at the export step if such errors occur.

The failed Joint appears in your generated model as a Weld. You can fix such an error in two ways:

- Return to the original CAD assembly, reconfigure the constraint, and export it again.
- In the generated model, manually replace this Weld with a proper moving Joint.

Tip If you need reference coordinate systems on Bodies to facilitate repairing mistranslated Joints after import, see “Inserting Reference Coordinate Systems into Assemblies Before Export” on page 4-41.

Troubleshooting Errors During Model Update

Update-importing an existing generated model can produce the same types of errors as importing a new model. The preceding discussion in this section explains these potential errors and how to identify and fix them.

In addition, you might update-import an existing generated model in a way that is technically correct, but not what you intended. To prevent such inadvertent errors, review:

- “Model Update with Physical Modeling XML” on page 4-20
- “Controlling Model Update at the Block Level” on page 4-29

Troubleshooting Model Simulation Errors

Certain problems with CAD-based models appear only when you run the model.

- You must “fix” at least one part in every CAD subassembly by mating it to the subassembly root. Otherwise, the massless root body is dynamically active and experiences infinite acceleration when forces or torques are applied to it.
- If you find constraints are violated while your model is running, try the following:
 - Examine your original CAD assembly for redundant constraints.
 - Check and possibly increase the assembly tolerances at the original CAD export step.
 - Check and possibly increase the translated model's assembly tolerances in the machine's Machine Environment block, in the **Parameters** tab.
 - On the **Constraints** tab in the Machine Environment dialog, select the **Use robust singularity handling** check box.
 - Decrease the assembly tolerances at the original CAD export step.

Caution Never *decrease* assembly tolerances in a CAD-based SimMechanics model. Instead, decrease them in the original assembly, then reexport.

Troubleshooting SimMechanics and Simulink Problems

You might also encounter general Simulink or SimMechanics problems while running your model.

- For SimMechanics problems, see “Troubleshooting Simulation Errors”.
- For general Simulink problems, consult the Simulink documentation.

Import a CAD Rigid Body

This example shows you how to import a simple CAD assembly into SimMechanics. The assembly is a simple cup with zero mechanical degrees of freedom. The example requires export of the cup assembly from a supported CAD platform using SimMechanics Link. For a step-by-step description of the export procedure, see “Export a CAD Rigid Body”.

To generate a model from a CAD assembly, you import the Physical Modeling XML file that SimMechanics Link generates during CAD Export.

- 1 Move or copy the exported XML file into a MATLAB working folder to generate a SimMechanics model from the file.
- 2 Generate the model from `cup_assembly.xml` with the `mech_import` command.

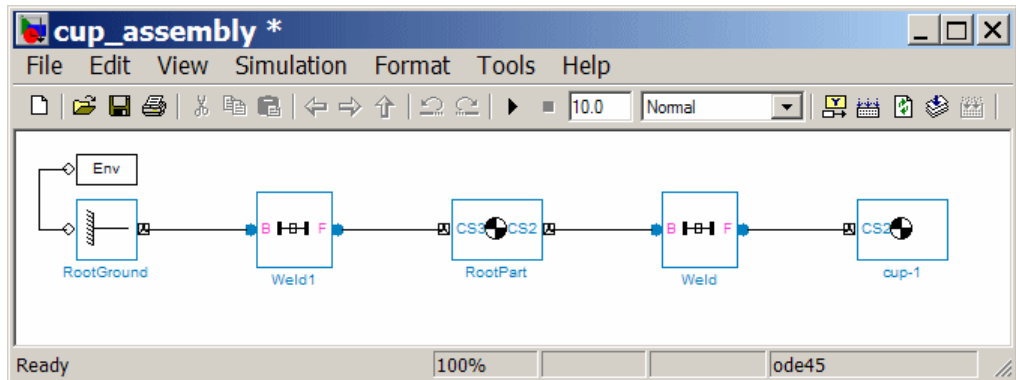

Once you generate the SimMechanics model, it has six blocks, a combination representing the entire assembly:

Machine Environment – Root Ground – Weld – Root Part – Weld – Cup

- The Ground origin is coincident with the World origin and maps the CAD assembly origin.
- The Root Part is a nondynamical zero-mass/zero-inertia body inserted between ground and the cup.
- The second joint is a Weld because the original CAD assembly has no degrees of freedom.

Deleting the Root Part and one of the Welds does not physically change the model, as long as you reconnect the remaining blocks.

Import Robot Arm Model

This example shows you how to import the model of a robot arm CAD assembly. The import procedure makes use of the `mech_import` command. You use the command to specify the Physical Modeling XML file that SimMechanics Link generated during CAD Export. For a step-by-step description of the CAD Export procedure, see “Export CAD Robot Arm”.

Generate a SimMechanics model for the robot arm based on the file `robot.xml`. You can use this preconfigured example file or export your own version of the XML file from the robot arm CAD assembly. In either case, copy or move the XML file to your MATLAB working folder.

Import SimMechanics XML File

The preconfigured `robot.xml` file is in the SimMechanics demos folder.

- 1 Generate the model by entering `mech_import('robot')` at the command line.

The status bar opens and indicates the progress of model generation. A model window, named **robot**, opens and is populated with blocks.

- 2 Save this initial body-joint model as `robot`, and note these properties:

- The top level of the model has 13 blocks and the `grip-1` subsystem.
- The `grip-1` subsystem has 18 blocks.

The original robot arm assembly has eight DoFs, with two in the `grip` subassembly and six at the top level. These translate into eight DoFs in the SimMechanics model, where:

- Six DoFs occur at the top level. These include the upper arm relative to the base, the forearm relative to the upper arm, the wrist relative to the forearm, and the grip relative to the wrist.
- Two DoFs occur in the `grip-1` subsystem. These are the rotational DoFs of the two grip fingers.

There are eight revolute primitives in the subsystem. They occur in two closed loops as two independent four-bar mechanisms. Each four-bar mechanism actually has only one independent DoF because each four-bar loop closes on itself.

Note: See “Model and Simulate a Closed-Loop Machine” and “Counting Model Degrees of Freedom”.

Modify Imported Model

To modify and extend the robot arm model, you need blocks from the SimMechanics and Simulink block libraries. Open these libraries by entering `mechlib` and `simulink`, respectively, at the command line.

Remove Redundant Rigid Bodies

Some of the bodies in the generated robot arm model are redundant. You can remove them without affecting the model's dynamics, as long as you properly reconnect the remaining blocks.

- At the top level, the `SimMechanics_RootPart` block is a zero-mass, zero-inertia Root Body. You can delete it, along with the connected `Weld1` block, then reconnect the Root Ground to the `base-1` block through the `Weld` block.
- In the `grip-1` subsystem, you can delete the `grip-1 (Root Body)` block and the connected `Weld` block because they are unnecessary. You can also delete the associated Body coordinate system on the `metacarpal-1 Body` block.

See the reference page for more details about the Body block.

Add Actuator and Sensor Blocks

You can motion-actuate the wrist relative to the forearm.

- 1 Double-click the Revolute that connects the `forearm-1` and `wrist-1` Body blocks. Change the **Number of sensor/actuator ports** to 2.
- 2 Click **OK**. Two new ports appear on the Joint.
- 3 Add the following blocks to the model and connect them to the two new ports.

Block	Library	Quantity
Joint Actuator	Sensors and Actuators	1
Joint Sensor	Sensors and Actuators	1

- 4 Configure the Joint Actuator to accept motion signals. Be sure the angular units are deg (degrees).
- 5 From the Simulink library, insert a Sine Wave, a Mux, two Integrator blocks, and one Scope block. Connect them to the previous blocks as shown in the following figure. Rename the Scope block to Pitch Angle.

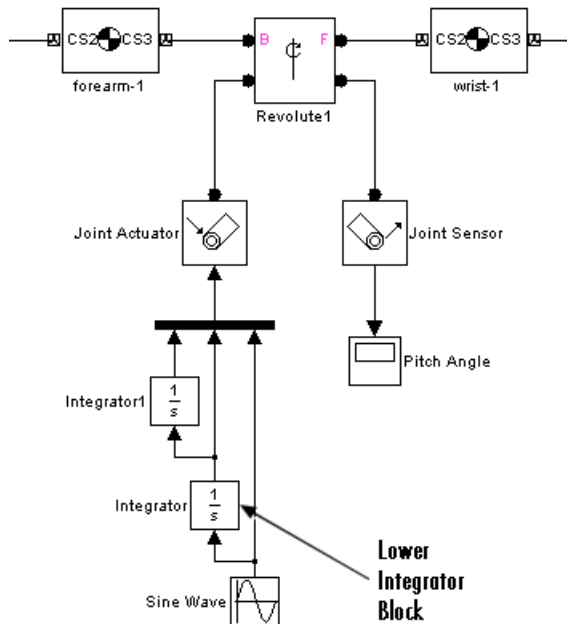

- 6 In the Sine Wave block, set the **Amplitude** to $60 \cdot \pi \cdot \pi$ and the **Frequency** to 60. Leave all other defaults.
- 7 In the lower Integrator block, set **Initial condition** to $-60 \cdot \pi$. Leave all other defaults.

Configure Tolerances

The original robot arm CAD assembly requires looser tolerances than the SimMechanics defaults, and its motion can lead to singularities. To avoid simulation errors or slowdown, you need to reconfigure the assembly tolerances and constraint solver:

- 1 Open the Machine Environment block.

- 2 On the **Parameters** tab, reset the **Linear assembly tolerance** to $1e-2$ m (meters) and the **Angular assembly tolerance** to $1e-1$ rad (radians).
- 3 On the **Constraints** tab, select the **Use robust singularity handling** check box. Leave all other defaults. Click **OK**.
- 4 Resave your finished model as robot3.

Simulate and Visualize Robot Arm Motion

Run robot3 and examine its motion.

To use the motion sensor:

- 1 Double-click the Pitch Angle block to open a scope.
- 2 Click the **Start simulation** button. The scope plot displays a trace of the pitch angle motion.

To visualize the body motions:

- 1 In the Simulink Editor window that contains your model, select **Simulation > Model Configuration Parameters**.
- 2 In the **SimMechanics 1G** node, select **Display machines after updating diagram** and **Show animation during simulation**.
- 3 Click **OK**.
- 4 In the Simulink Editor window that contains your model, select **Simulation > Update Diagram**. The SimMechanics visualization window opens.
- 5 In the **SimMechanics** menu of the visualization window, select **Machine Display**, then **Ellipsoids**. The display now shows the robot arm's component bodies as ellipsoids.
- 6 Click the **Start** button. The simulation begins. Observe the robot arm motion in the SimMechanics window.

Import a CAD Stewart Platform Model

This example shows you how to import the model of a Stewart platform CAD assembly. The import procedure makes use of the `mech_import` command. You use the command to specify the Physical Modeling XML file that SimMechanics Link generated during CAD Export. For a step-by-step description of the CAD Export procedure, see “Export a CAD Stewart Platform”

Move or copy the `stewart_platform.xml` file into your working MATLAB folder.

To generate a new Simulink model, enter `mech_import('stewart_platform')` at the MATLAB command line, and wait for the model generation `stewart_platform` to finish.

Review Generated Model and Count DoFs

The complete Stewart platform model contains seven subsystems.

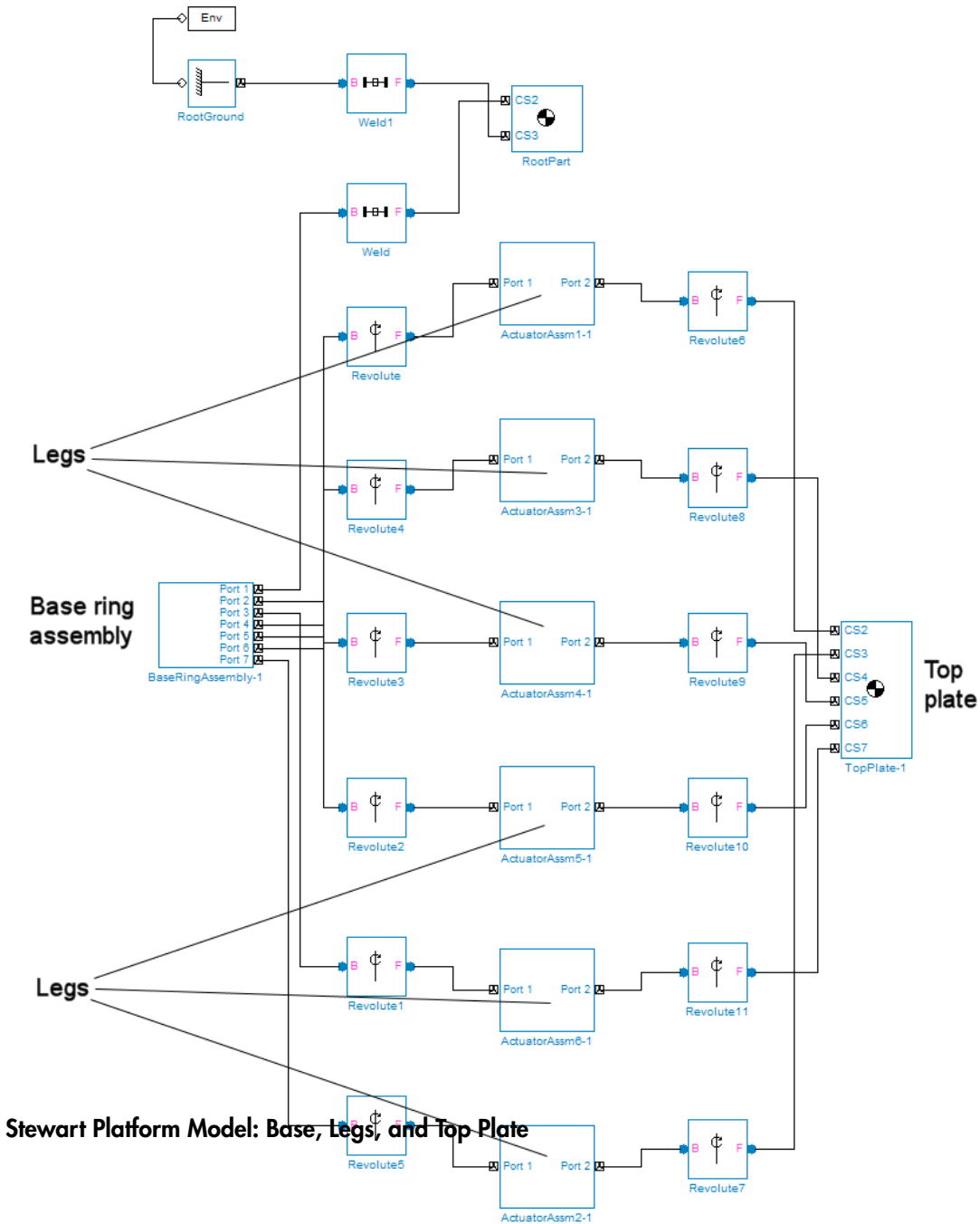

The subsystems correspond to the subassemblies of the original CAD assembly — the base plate and the six platform legs.

- The base plate subassembly **BaseRingAssembly - 1** contains six subassemblies, modeling a base swivel bearing for each leg.
- The six leg subassemblies, **ActuatorAssm**, model the upper and lower halves of each leg and represent part of their DoFs.

For each leg, there are six DoFs. Two pairs of revolute associated with each leg represent the two universal joints connecting each leg to the top and base plates, respectively. Each of these universals has two DoFs.

- At the top level, there are two revolute, one attached to either end of a leg subassembly, connecting each leg to the base and top plates, respectively.
- Within each leg subassembly, there are two other revolute, each one connecting the leg to the top and base plates, respectively.

One of the revolute inside the leg subassembly pairs with one of the revolute outside the leg assembly to make up a two-DoF universal. These pairs occur twice on each leg, one connecting the leg to the top plate, the other connecting the leg to the base plate.

- Within each leg subassembly, there is one prismatic, representing the leg's freedom to expand or contract along its shaft.
- Within each swivel bearing subassembly, itself located within the base ring assembly, is another revolute representing each leg's freedom to rotate about its shaft.

Each leg has six DoFs. However, the constraints imposed by attaching each leg to fixed points on the base and top plates, respectively, reduce these to one independent DoF for each leg — the freedom to expand or contract along its shaft.

- The rotational DoFs associated with the universals at the attachment points are completely dependent on the leg's prismatic DoF.
- The rotational DoFs associated with the cylindricals in each leg are completely dependent on the universals at the top and bottom of each leg.

Delete Unnecessary Bodies and Joints

The generated model contains a large number of redundant Root Weld and zero-mass Root Part blocks. You can delete these and not affect the model's dynamics, as long as you take care to reconnect the remaining bodies properly after deleting each Weld.

Add Actuators and Sensors

If you want the motion of the platform to be controlled by something other than gravity, you need to add the appropriate Actuators to the model. To quantify the model's motion, you need to make precise measurements with Sensors. You can drive the actuators with external control signals to model an open-loop controller for the Stewart platform. If you introduce feedback from the sensors to the actuators, you can model a closed-loop controller.

Visualize Stewart Platform Motion

Without any external forces acting, apart from gravity, the platform collapses under its own weight. You can verify this by running and visualizing your Stewart platform model.

- 1 In the Simulink Editor window that contains your model, select **Simulation > Model Configuration Parameters**.
- 2 In the **SimMechanics 1G** node, select **Display machines after updating diagram** and **Show animation during simulation**.
- 3 Click **OK**.
- 4 In the Simulink Editor window that contains your model, select **Simulation > Update Diagram**. The SimMechanics visualization window opens with the SimMechanics controls. The window displays the Stewart platform in its initial position.
- 5 Start the simulation by clicking the **Start** button in the toolbar of either the visualization window or the model window.

The mobile plate falls under its own weight and reaches the base plate in about 0.2 seconds. Because there is nothing to stop the legs or the top plate, the platform continues to collapse: the mobile plate falls below the base plate, and the upper and lower parts of each leg come apart.

This visualization of the Stewart platform uses custom body visualization with the STL body geometry files exported from the original CAD assembly.

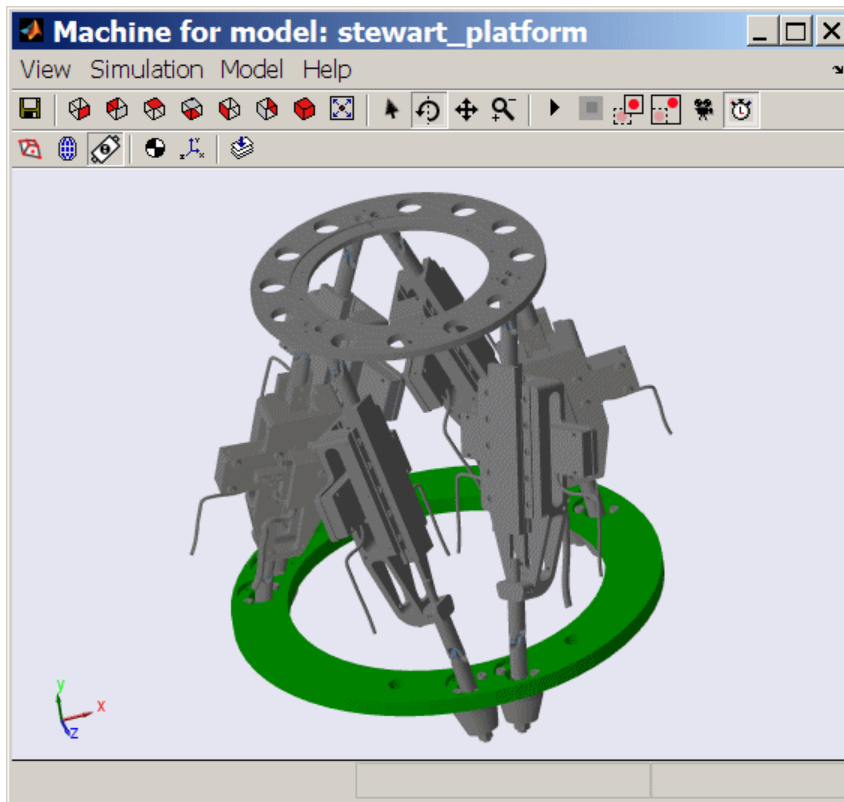

SimMechanics Visualization of the CAD-Based Stewart Platform (Custom Body Geometries)

Computer-Aided Design Translation

These case studies illustrate how to translate mechanical systems defined externally, as computer-aided design (CAD) assemblies, into mechanical models.

- “Case Study Overview” on page 5-2
- “Export a CAD Rigid Body” on page 5-4
- “Translate CAD Constraints into SimMechanics Joints” on page 5-7
- “Export and Re-Export a Pendulum Assembly” on page 5-19
- “Export CAD Robot Arm” on page 5-38
- “Export a CAD Stewart Platform” on page 5-41

Case Study Overview

In this section...
“Requirements” on page 5-2
“Terminology” on page 5-2

The case studies show how to export a computer-aided design (CAD) assembly into a SimMechanics model using the SimMechanics Link utility. Case studies include:

- — Translate CAD assembly with a single part into a SimMechanics model with a single rigid body.
- “Translate CAD Constraints into SimMechanics Joints” — Translate CAD assemblies with two constrained parts into SimMechanics models with two rigid bodies connected by a joint.
- “Export and Re-Export a Pendulum Assembly” — Modify a CAD assembly and update the imported SimMechanics model.
- “Export CAD Robot Arm” — Translate an intermediate CAD assembly containing a simple subassembly hierarchy.
- “Export a CAD Stewart Platform” — Translate a advanced CAD assembly with a complex subassembly hierarchy.

Requirements

The following assembly and exporting examples require a CAD platform supported by the SimMechanics Link utility. To complete all the steps, you also need SimMechanics Link and SimMechanics software.

The example CAD files are under `$matlabroot/toolbox/physmod/smlink/smlinkdemos/`, in the subfolder appropriate to your supported CAD platform. The file extensions of these files are specific to each CAD platform.

The assembly, geometric, kinematic, and part details differ from platform to platform. In SolidWorks®, constraints on CAD parts are called *mates*.

Terminology

The glossary in the SimMechanics Reference defines CAD terms. Terms include:

- assembly
- constraints
- coordinate systems
- degrees of freedom
- fixed part
- fundamental root
- ground
- part
- root body
- subassembly and subassembly root

Export a CAD Rigid Body

In this section...
“Access the Example Files” on page 5-4
“Examine Rigid Body Parameters” on page 5-4
“Export CAD Rigid Body” on page 5-6
“Import CAD Rigid Body” on page 5-6

Access the Example Files

In this example, you export an assembly with one part and no constraints. Look for the following two example CAD files in the SimMechanics Link examples folder:

- The full assembly file, `cup_assembly.ASSEMBLYFILETYPE`
- The part, a cup, in a file called `cup.PARTFILETYPE`

Although it has only one part, you must export the full assembly into XML, not just the cup part.

Examine Rigid Body Parameters

Open the cup assembly file in your CAD platform and check its geometry and mass properties.

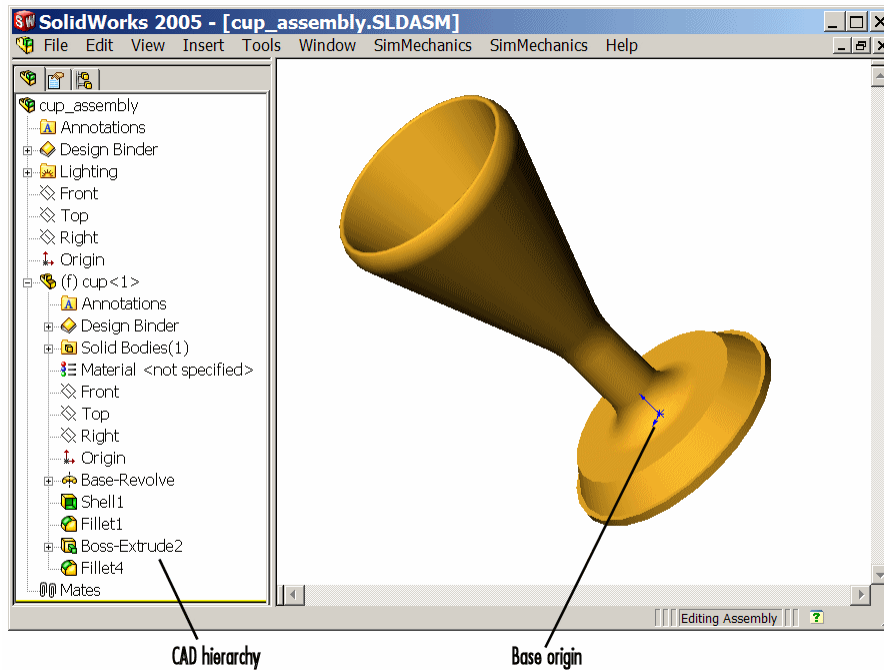

Cup Assembly in a CAD Platform

Property	Value
Volume	0.0001 cubic meters (m ³)
Surface area	0.0381 square meters (m ²)
Density	3.0 grams/cm ³ = 3000 kg/m ³
Mass	0.2906 kilograms (kg)
Principal moments of inertia at the center of gravity	$I_x = 0.00015$, $I_y = 0.00067$, $I_z = 0.00067$ kg-m ²

The inertia tensor is computed at the center of gravity, with the coordinate axes aligned with assembly base-origin axes, indicated in the figure. The x -axis is the cup's axis of symmetry, and the y - and z -axes point across the cup.

Export CAD Rigid Body

Using the SimMechanics Link interface to your CAD platform, export the assembly into Physical Modeling XML format. The XML file `cup_assembly.xml` appears in your working CAD folder.

Import CAD Rigid Body

Once you have generated the Physical Modeling XML file, you are ready to import the cup assembly into a SimMechanics model. For a step-by-step description of the CAD Import procedure, see “Import a CAD Rigid Body”.

Translate CAD Constraints into SimMechanics Joints

In this section...

“Access the Example Files” on page 5-8

“Translation of Two-Part Models” on page 5-8

“Block Structure of Two-Part Models” on page 5-9

“Translate Assembly with Six-DoF Joint” on page 5-10

“Translate Assembly with Prismatic Joint” on page 5-11

“Translate Assembly with Revolute Joint” on page 5-14

“Translate Assembly with Rectangular Joint” on page 5-15

“Translate Assembly with Spherical-Spherical Massless Connector” on page 5-16

In “Export a CAD Rigid Body”, you create and export an assembly composed of a single part. Because there are no other parts in that CAD assembly, the SimMechanics body is welded to ground and has no degrees of freedom (DoFs). This lack of DoFs is not realistic for most assemblies.

This study presents a set of complete CAD assemblies with both parts and constraints and possessing DoFs. Each example assembly consists of two instances of the same part file, representing two identical cubes. The study shows how to find the required files, presents the essential steps for generating models from them, and describes the structure common to all the generated models. It ends with specific assembly cases that include two cubes:

- With no constraints, so that the cubes have the full six degrees of freedom relative to one another
- Constrained in two different ways so as to produce the same result, a single prismatic (translational) DoF between them
- Constrained so as to allow only a single revolute (rotational) DoF between them
- Constrained so as to allow two prismatic (translational) DoFs between them
- Constrained so as to allow relative spherical joint motion, with the two cubes separated by a constant nonzero distance

In different assemblies, the two cubes are constrained with different constraint combinations to create different relative DoFs between the cubes. In most cases, you can represent one set of DoFs with a large number of different combinations of constraints.

Access the Example Files

Look for the CAD assembly files of this study in the *smlink/smlinkdemos* directory. The assemblies have the generic name, `<assembly-name>.ASSEMBLYFILETYPE`. The cube part is in `magic_cube.PARTFILETYPE`.

Assembly Name	Assembly Configuration
sixDOF	Two cubes with no constraints
prismatic1	Two cubes with planar and cylindrical constraints
prismatic2	Two cubes with planar constraints
revolute	Two cubes with planar and cylindrical constraints
inplane	Two cubes with planar constraints
spherical_spherical_ massless_connector	Two cubes with a distance constraint

Translation of Two-Part Models

The procedure for exporting a two-part assembly and generating SimMechanics models based on it is essentially the same for all the examples of this study.

Export Assembly

To see a two-part assembly and export it into a Physical Modeling XML file:

- 1 Open the assembly, `<assembly-name>.ASSEMBLYFILETYPE`. The two parts are `magic_cube-1` and `magic_cube-2`.

Locate any constraints imposed on the parts. These constraints define the relative DoFs between the parts.

- 2 Using the SimMechanics Link interface to your CAD platform, export the CAD assembly into Physical Modeling XML. The XML file is saved in your current working CAD folder.

Import Model

You can import the Physical Modeling XML file into SimMechanics. SimMechanics interprets the file and generates a corresponding SimMechanics model. The new model is based on XML file structure and parameters. The CAD Import procedure requires access to SimMechanics.

- 1 Move or copy the XML file to a working MATLAB folder. In this folder, open MATLAB.
- 2 At the command line, enter `mech_import(' <assembly_name>')` to automatically generate a model, `<assembly_name>.mdl`, based on `<assembly_name>.xml`.
- 3 Open the subsystem. The blocks are arranged in the common structure described in “Block Structure of Two-Part Models”. A set of Joints represents the DoFs between the two cubes.

Block Structure of Two-Part Models

In this study, all the models that you generate each have eight blocks. From the example CAD assemblies, the models have a common structure because each assembly has a fundamental root and two moving parts:

- *The assembly fundamental root.* As in any generated CAD-based model, the four-block combination Machine Environment – Root Ground – Root Weld – Root Part represents the assembly fundamental root. The Root Part is a nonmoving, zero-mass/zero-inertia body.
- *The moving bodies.* The bodies representing the assembly parts are `magic_cube-1` and `magic_cube-2`.
- *The joints.* In all the models, the first cube is connected by a Weld to Root Part and cannot move. The second cube is connected to RootPart by a Joint that represents the appropriate degrees of freedom (DoFs).

Depending on the DoFs in a particular assembly, CAD translation configures the Joint to represent different DoFs with combinations of prismatic, revolute, and spherical primitives. The second cube can move with respect to the first cube through the DoFs represented by the Joint.

Some of the blocks in the generated models are redundant. You can manually edit and simplify the models without changing their physical properties.

CAD Constraints Restrict Degrees of Freedom

CAD platforms treat unconstrained parts as free rigid bodies with six mechanical degrees of freedom. To reduce the degrees of freedom of a CAD part, and therefore the ways that part can move, you must *constrain* that part. Applying a CAD constraint between two parts reduces the ways the two parts can move with respect to each other. In a two-part CAD assembly, one part is static relative to ground.

Translate Assembly with Six-DoF Joint

The simplest assembly with two parts has no constraints between the parts. The parts can move with respect to one another with all six degrees of freedom (DoFs).

Export Assembly

To see and export the assembly:

- 1 Open the assembly, `sixDOF.ASSEMBLYFILETYPE`.

The cube parts have no constraints. Therefore, relative to one another, the cubes are unconstrained in their motion and have six relative DoFs.

- 2 Export this CAD assembly into the file, `sixDOF.xml`.

Import Model

To generate a model based on the assembly:

- 1 At the MATLAB command line, enter `mech_import('sixDOF')` to generate a model, `sixDOF.mdl`.
- 2 Inspect the model. There are eight blocks.

The Six-DoF Joint represents the six DoFs between the two cubes with one spherical and three prismatic primitives.

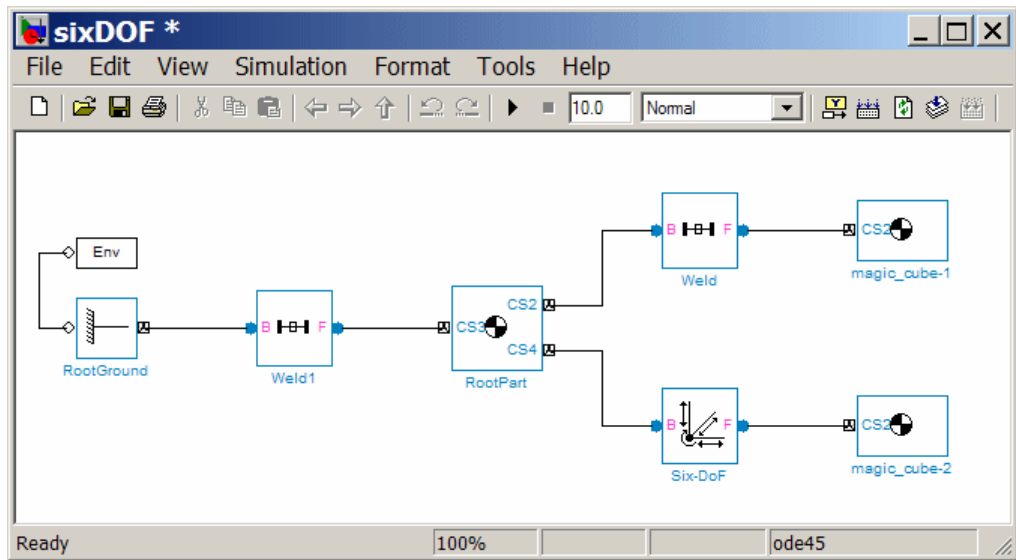

Translate Assembly with Prismatic Joint

In the following two assemblies, the two cubes are constrained to have only a single translational degree of freedom (DoF) between them. These assemblies illustrate two ways to express one translational degree of freedom. You can experiment with other constraints to find more. In the translated SimMechanics models, this single DoF is a prismatic joint.

Prismatic as a Cylindrical Constraint and a Planar Constraint

To see the first way of constraining the DoFs to produce a prismatic joint:

- 1 Open the assembly file, `prismatic1.ASSEMBLYFILETYPE`, and examine its CAD hierarchy.
- 2 Locate the two constraints on the two cubes.
 - Highlight the cylindrical constraint in the assembly. This constraint allows the two cubes to only slide along and rotate about the z -axis running through the center of the parallel and concentric upper holes of each cube.
 - Highlight the planar constraint in the assembly. This constraint allows the two cubes to slide along the y - z plane, with the two sides marked “SimMechanics”

sharing a common plane, representing two translational DoFs. The constraint also allows the two cubes to rotate about the x -axis. The cubes are not allowed to rotate about any other axis, or to translate perpendicular to the y - z plane.

With these two constraints, the two cubes can only slide along the z -axis common to the two upper concentric holes. The second constraint prevents rotation about this axis, leaving the whole assembly with only one translational DoF.

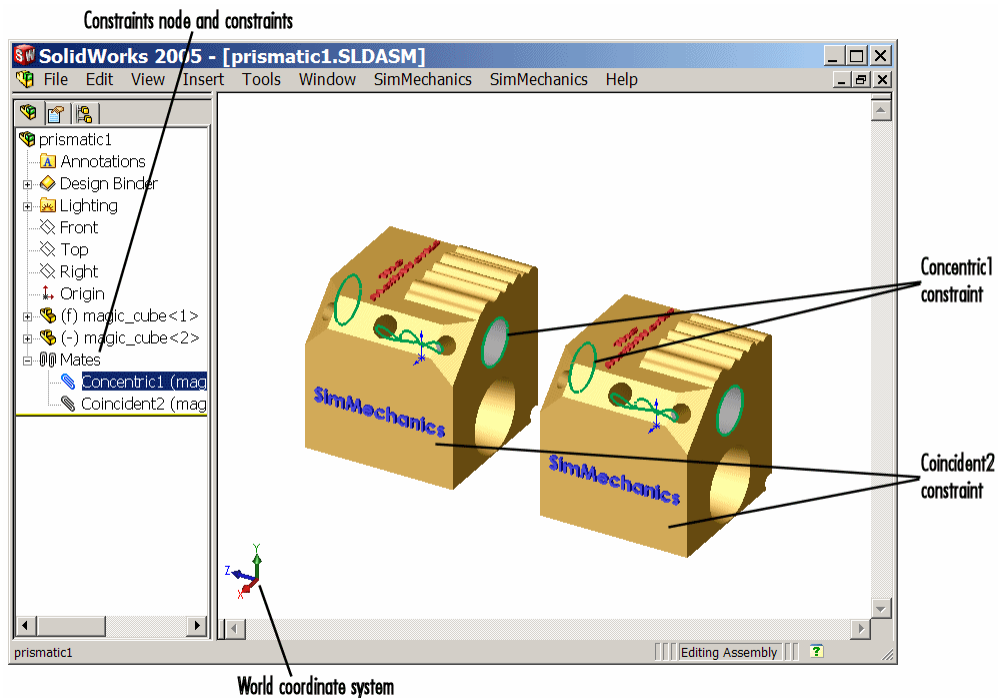

Cylindrical and Planar Constraints on Two Cubes (SolidWorks)

Prismatic as Two Orthogonal Planar Constraints

To see the second way of constraining the DoFs to produce a prismatic joint:

- 1 Open the assembly file, `prismatic2.ASSEMBLYFILETYPE`, and examine its CAD hierarchy.
- 2 Locate the two constraints on the two cubes.

- Highlight the first planar constraint in the assembly. This constraint allows the two cubes to slide along the y - z plane, with the two sides marked “SimMechanics” sharing a common plane, representing two translational DoFs. It also allows the two cubes to rotate about the x -axis. The cubes are not allowed to rotate about any other axis, or to translate perpendicular to the y - z plane.
- Highlight the second planar constraint in the assembly. This constraint allows the two cubes to slide along the x - z plane, with the two sides marked “The MathWorks” sharing a common plane, representing two translational DoFs. The constraint also allows the two cubes to rotate about the y -axis. The cubes are not allowed to rotate about any other axis, or to translate perpendicular to the x - z plane.

With these two constraints, the two cubes can only slide along the z -axis common to the two planes y - z and x - z , leaving the whole assembly with only one translational DoF.

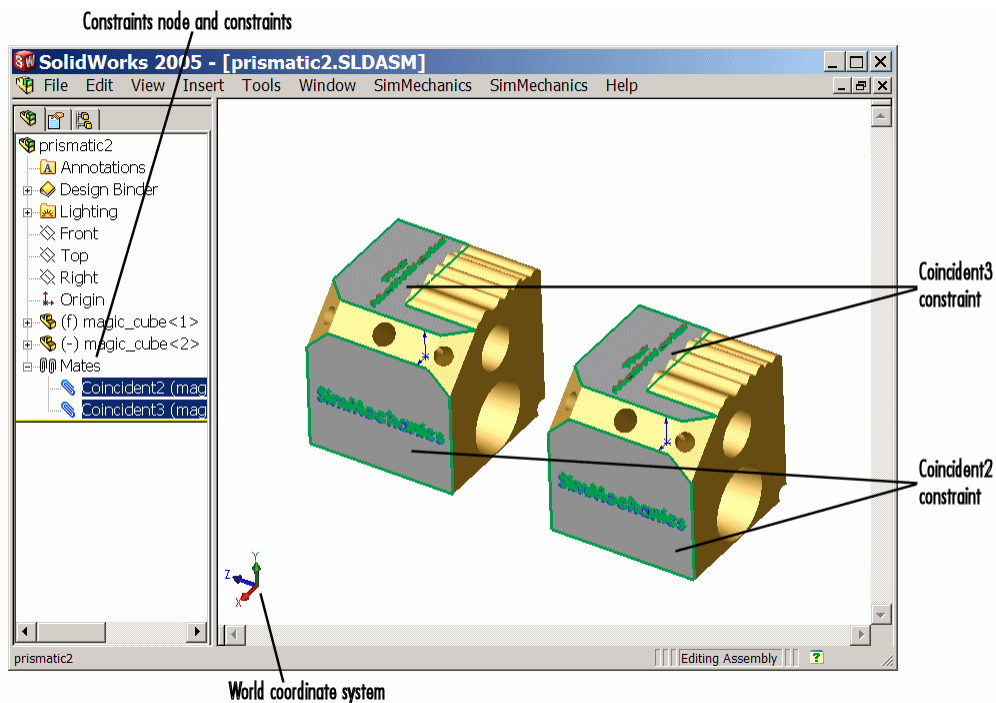

Two Planar Constraints on Two Cubes (SolidWorks)

Export Assemblies and Import Models

To create models from the assemblies:

- 1 Export the two assemblies into the XML files, `prismatic1.xml` and `prismatic2.xml`.
- 2 Copy or move them to a MATLAB working folder. At the MATLAB command line, generate SimMechanics models using `mech_import`.

In both models, the assemblies are translated into block diagrams of eight blocks each. The Prismatic Joint represents the single translational DoF between the two cubes with one prismatic primitive along the z -axis.

Translate Assembly with Revolute Joint

In the following assembly, the two cubes are constrained to have only a single rotational degree of freedom (DoF) between them. In the translated SimMechanics model, this single DoF is a revolute joint.

Open CAD Assembly

To see an assembly with one rotational DoF:

- 1 Open the assembly file, `revolute.ASSEMBLYFILETYPE`, and examine its CAD hierarchy.
- 2 Locate the two constraints on the two cubes.
 - Highlight the cylindrical constraint in the assembly. This constraint allows the two cubes to slide along and rotate about the z -axis running through the center of the parallel and concentric upper holes of each cube.
 - Highlight the planar constraint in the assembly. This constraint allows the two cubes to slide along the x - y plane, with the parallel sides sharing a common plane. The constraint also allows the two cubes to rotate about the z -axis. The cubes are not allowed to rotate about any other axis, or to translate perpendicular to the x - y plane.

With these two constraints, the two cubes can only rotate about the z -axis orthogonal to the x - y plane, leaving the whole assembly with only one rotational DoF.

Export Assembly and Import Model

To generate a model based on the assembly:

- 1 Export the assembly as the file, `revolute.xml`. Copy or move it to a MATLAB working folder.
- 2 At the MATLAB command line, generate a SimMechanics model using `mech_import`.

The assembly is translated into a block diagram of eight blocks. The Revolute Joint represents the single rotational DoF between the two cubes with one revolute primitive about the z -axis.

Translate Assembly with Rectangular Joint

In the following assembly, the two cubes are constrained to have only two translational degrees of freedom (DoFs) between them. In the translated SimMechanics model, these two DoFs are two prismatic joints.

Open CAD Assembly

To see an assembly with two translational DoFs:

- 1 Open the assembly file, `inplane.ASSEMBLYFILETYPE`, and examine its CAD hierarchy.
- 2 Locate the two constraints on the two cubes.
 - Highlight the first planar constraint in the assembly. This constraint allows the two cubes to slide along the y - z plane, with the two sides marked “SimMechanics” sharing a common plane. The constraint also allows the two cubes to rotate about the x -axis. The cubes are not allowed to rotate about any other axis, or to translate perpendicular to the y - z plane.
 - Highlight the second planar constraint in the assembly. This constraint allows the two cubes to slide parallel to the x - z plane, with the two sides marked “The MathWorks” parallel but not necessarily in the same plane. It also allows the two cubes to translate perpendicular to the x - z plane and to rotate about the y -axis. The cubes are not allowed to rotate about any other axis.

With these two constraint, the two cubes can only slide in the y - z plane, leaving the whole assembly with only two translational DoFs.

Export Assembly and Import Model

To generate a model based on the assembly:

- 1 Export the assembly as the file, `inplane.xml`. Copy or move it to a MATLAB working folder.
- 2 At the MATLAB command line, generate a SimMechanics model using `mech_import`.

The assembly is translated into a block diagram of eight blocks. The In-Plane Joint represents the two translational DoFs between the two cubes with two prismatic primitives, along the y -axis and the z -axis.

Translate Assembly with Spherical-Spherical Massless Connector

In the following assembly, the two cubes are constrained to have six rotational degrees of freedom (DoFs) between them, represented by two spherical primitives. The spherical primitives pivot independently about two pivot points at a fixed relative distance. In the translated SimMechanics model, a spherical-spherical massless connector represents these six DoFs.

Open CAD Assembly

To see an assembly with three rotational DoFs separated from three other rotational DoFs:

- 1 Open the assembly file,

```
spherical_spherical_massless_connector.ASSEMBLYFILETYPE
```

and examine its CAD hierarchy.
- 2 Locate the one constraint on the two cubes.

Highlight this distance-offset constraint. The two spherical pivot points occur one on each cube and mark the endpoints of the rigid massless connector. The cubes can move so that the distance between these two endpoints (the length of the massless connector) does not change. The constraint allows the two cubes to pivot independently about their connector endpoints.

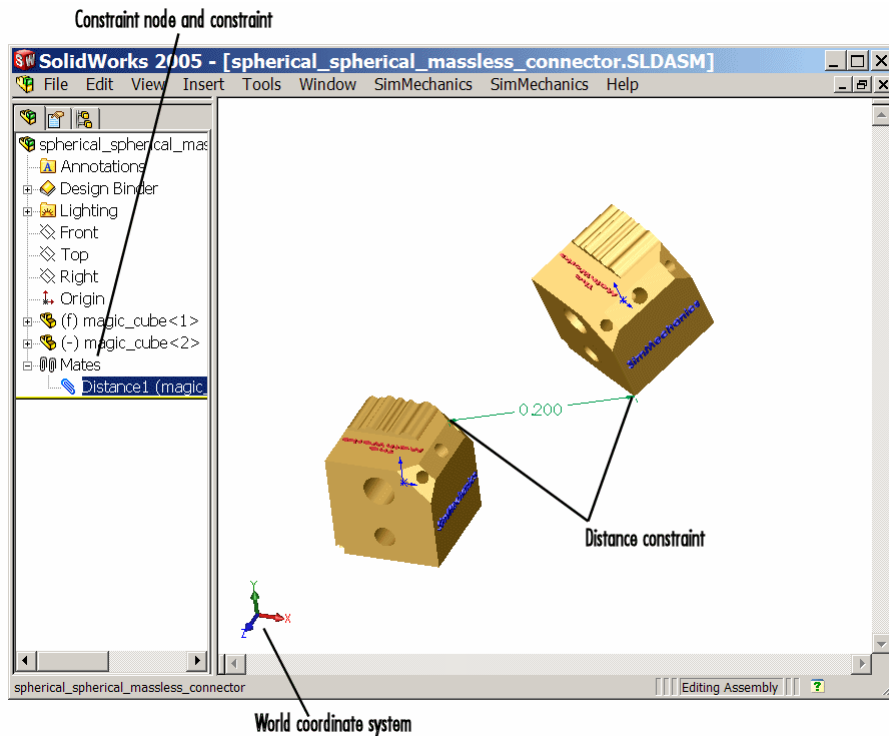

Distance Constraint on Two Cubes (SolidWorks)

Export Assembly and Import Model

To generate a model based on the assembly:

- 1 Export the assembly as a file,
 - spherical_spherical_massless_connector.xml
- 2 Copy or move it to a MATLAB working folder.
- 3 At the MATLAB command line, generate a SimMechanics model using `meh_import`.

The assembly is translated into a block diagram of eight blocks, arranged in the common structure described in “Block Structure of Two-Part Models”.

The Spherical-Spherical massless connector Joint block represents the two spherical primitives, each with three rotational DoFs, independently pivoting at each end of the massless, rigid connector connecting the two cubes.

Export and Re-Export a Pendulum Assembly

In this section...

“About Model Update” on page 5-19

“CAD Assembly Files” on page 5-19

“Translate CAD Assembly” on page 5-20

“Modify Pendulum Assembly and Update SimMechanics Model” on page 5-24

“Add New Body to Create a Triple Pendulum” on page 5-30

“Update Imported Model While Retaining Manual Joint Replacements” on page 5-35

“Selectively Update Imported Model” on page 5-36

About Model Update

Note: The CAD assembly files of this case study require Pro/ENGINEER®.

The following example shows how to update a previously generated SimMechanics model with a new XML file exported after changes have been made to the original CAD assembly. The example starts with a double pendulum assembly.

For a general discussion of retranslation and update-import, see the following sections:

- “Model Update with Physical Modeling XML”
- “Controlling Model Update at the Block Level”

CAD Assembly Files

Look for the following seven CAD files of this case study in the SimMechanics Link examples folder.

File Name	CAD File Type
dpen.ASSEMBLYFILETYPE	Assembly
tpen.ASSEMBLYFILETYPE	Assembly
hook.ASSEMBLYFILETYPE	Subassembly

File Name	CAD File Type
mid_part.PARTFILETYPE pend.PARTFILETYPE	Parts (main assembly)
hook.PARTFILETYPE hookbase.PARTFILETYPE	Parts (subassembly)

Translate CAD Assembly

Open the dpen assembly file and export it into an XML file.

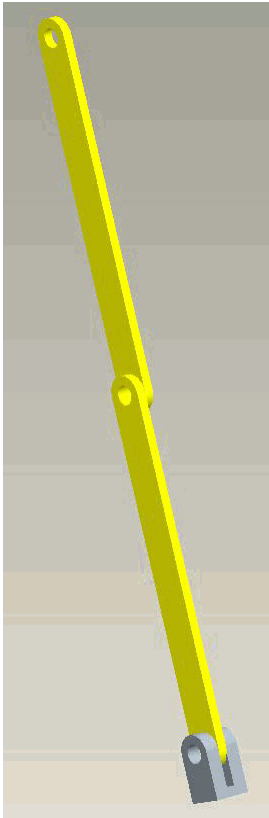

Export the assembly through the **SimMechanics Link** menu of the CAD platform's menu bar. The result is an XML file called `dpen.xml`.

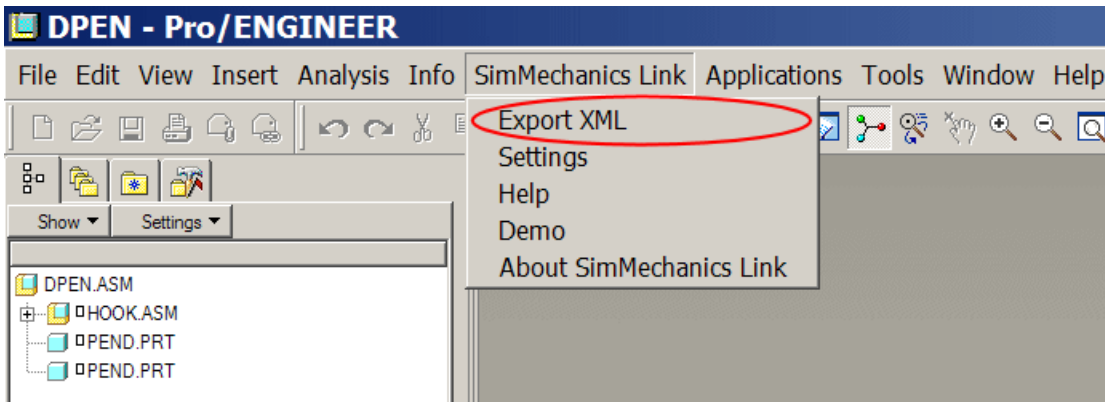

Import CAD Assembly and Generate SimMechanics Model

To import the XML file and generate the SimMechanics model, you can either use the import dialog box or work with the full command at the MATLAB command line.

Open the dialog box by entering `mech_import` at the command line.

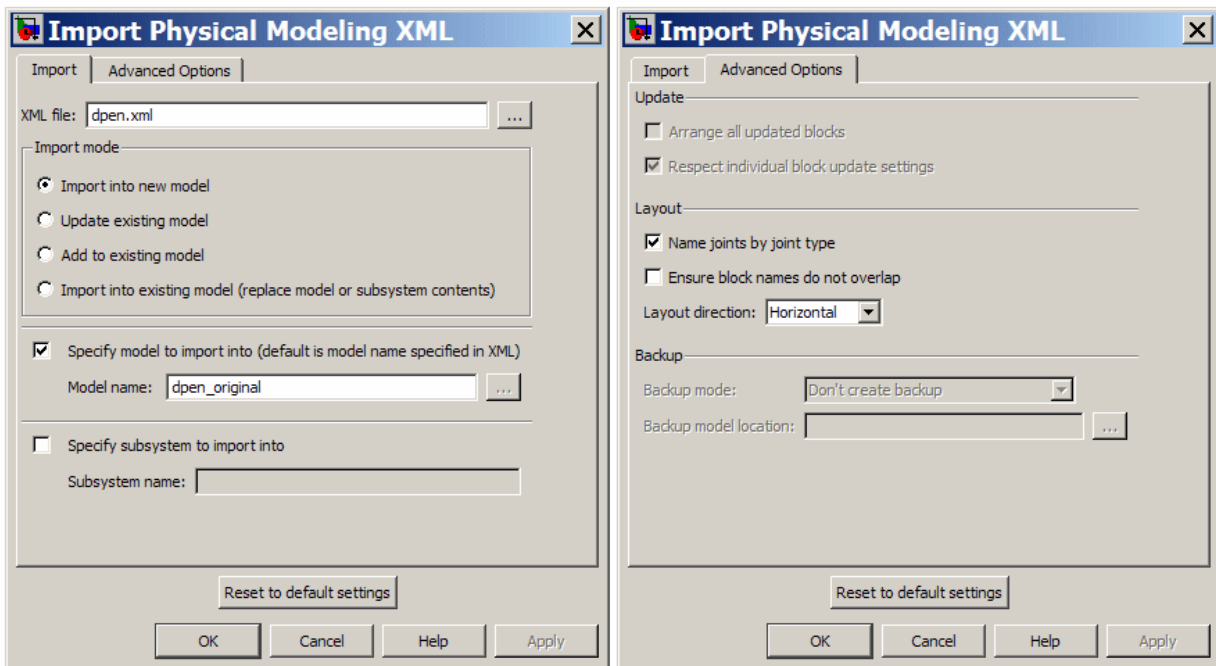

The alternative is to use the full command with specified import options:

```
mech_import('dpen.xml', 'ImportMode', 0, ...
           'ModelToImportInto', 'dpen_original');
```

This model results from the import step. The blocks are created at the top level.

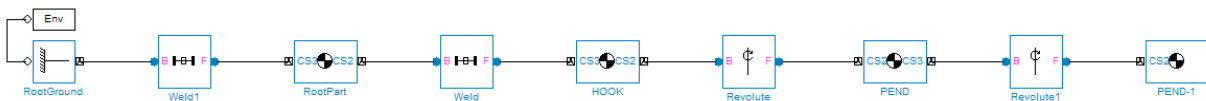

With visualization enabled, you see this SimMechanics model with custom bodies defined by STL files exported when the XML file was exported.

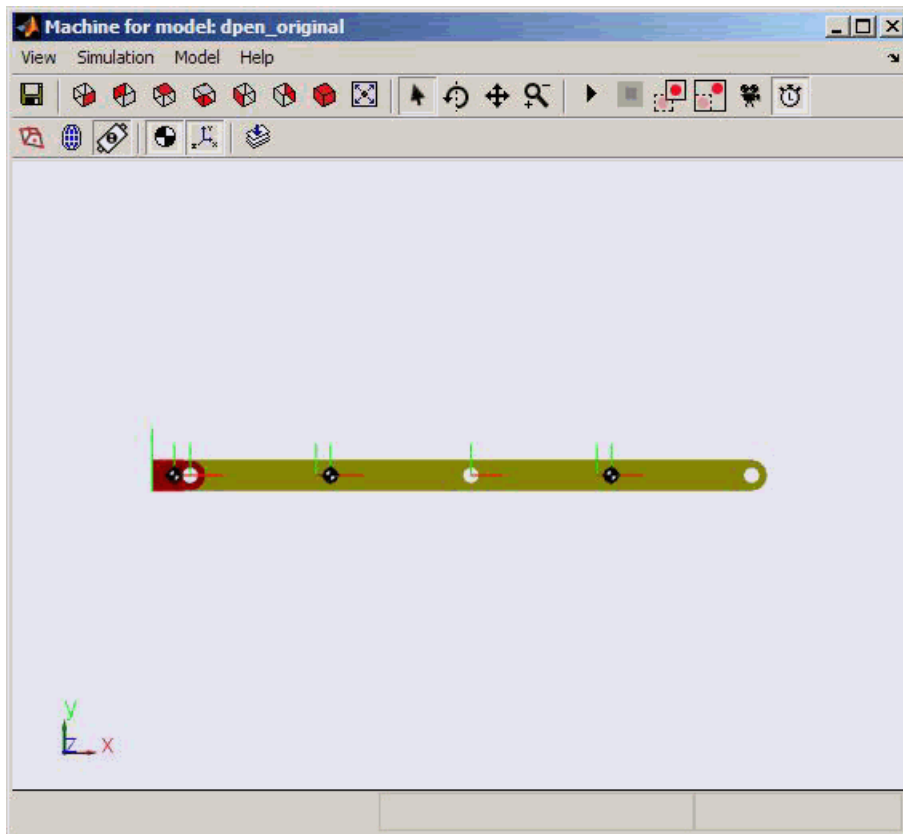

Import Physical Modeling XML File

If you want to import the assembly into a model subsystem, rather than at the top level of a model, use the `SubsystemToImportInto` option of the `mech_import` command. (You can also use the parallel options in the import dialog box.) For example, you can import the assembly into a subsystem named `Plant`.

```
mech_import('dpen.xml', 'ImportMode', 0, ...
            'ModelToImportInto', 'dpen_original', ...
            'SubsystemToImportInto', 'Plant');
```

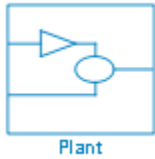

Modify Pendulum Assembly and Update SimMechanics Model

Note: The modified double pendulum model, `dpen_withsensors`, prior to the assembly changes, is available as a SimMechanics example, `mech_update_sensors`.

You can change part properties in the original assembly and reimport the assembly, with those changes, to update the model. You can also make direct changes by hand to the original generated model and preserve those changes even as you update it with assembly changes.

In this example, you now cut out material from the links to make them lighter. You also connect joint and body sensors in the SimMechanics model to implement a controller. Now you want to update the SimMechanics model with changes from the assembly without undoing the additions you made by hand.

Export Modified CAD Assembly

Change the double pendulum assembly and generate a new XML file from it.

- 1 Open the `pend` part file and unsuppress the `Extrude2` feature to enable the hole in the parts. Do this by right-clicking `Extrude2` in the tree view and selecting **Resume**.

Save the part file.

- 2 Open and re-export the `dpen` assembly file to obtain the new XML file, which is assumed to be named `dpen_with_holes.xml`.

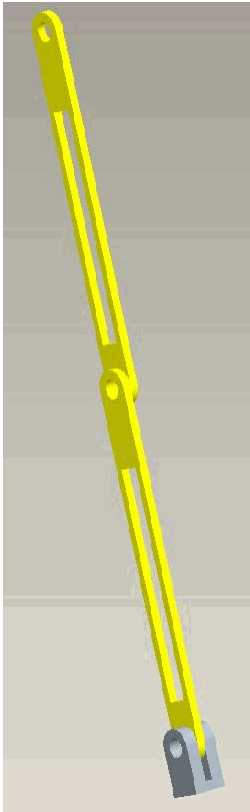

Modification to Imported SimMechanics Model

In this example, you have separately made the following changes, by hand, to the original generated model, now renamed `dpen_withsensors`. These changes include insertion of a Joint Sensor, a Body Sensor, and two Scope blocks.

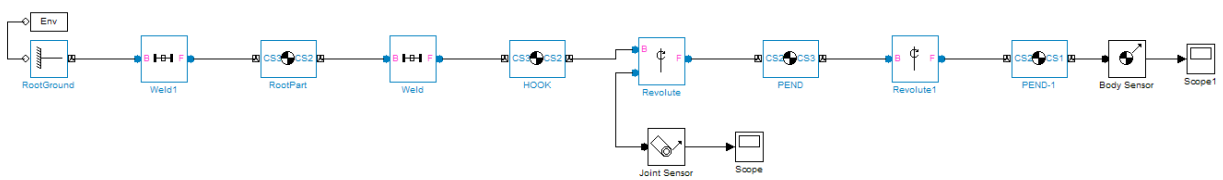

These are the properties of the PEND body before the update-import. PEND-1 has the same mass properties.

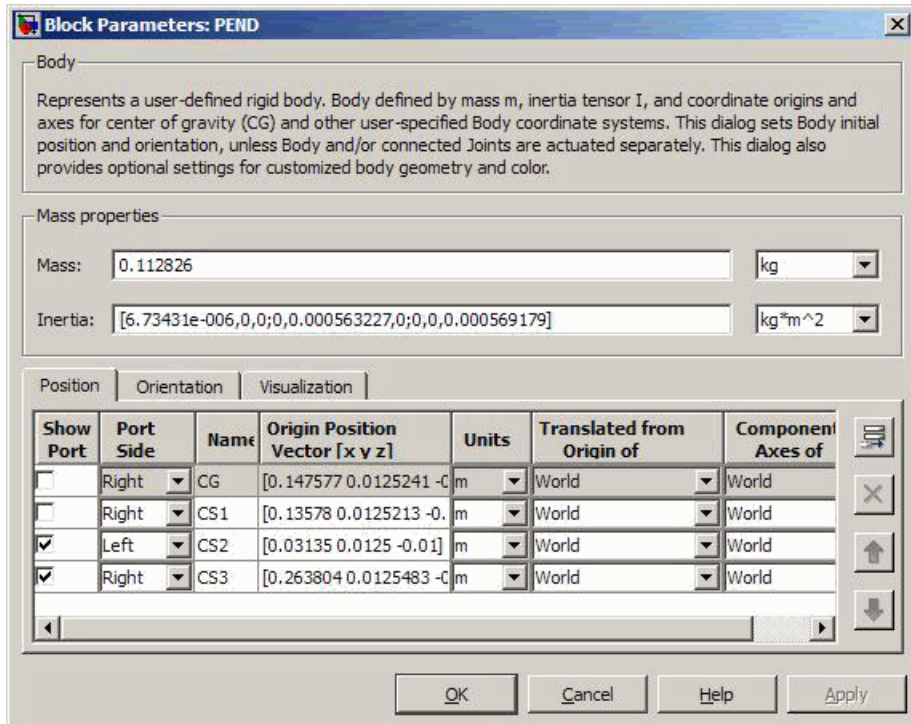

Preparation for Model Update

Before proceeding to the update-import from the updated CAD assembly, designate the manually added SimMechanics blocks that you want to retain and keep connected to the originally imported blocks. Right-click the sensor blocks and select the **Retain connectivity to imported blocks** option under the **SimMechanics** submenu. This option is selected by default.

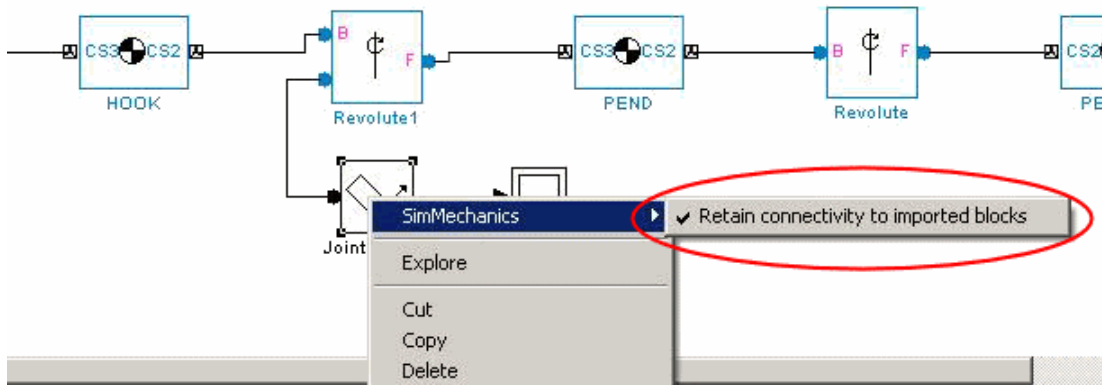

SimMechanics Model Update

Now update-import in such a way as to modify the PEND and PEND-1 body mass properties, without changing the manually added blocks and connections. You can either use the import dialog box or the command line with fully specified options to update the existing model. This example uses the dialog box, opened by entering `mech_import` at the command line.

The dialog box is configured so that `dpen_with_holes.xml` is the file imported to update the modified `dpen_withsensors` model. Because the dialog box is set to update an existing model, the **Update** and **Backup** options in the **Advanced Options** tab are now enabled.

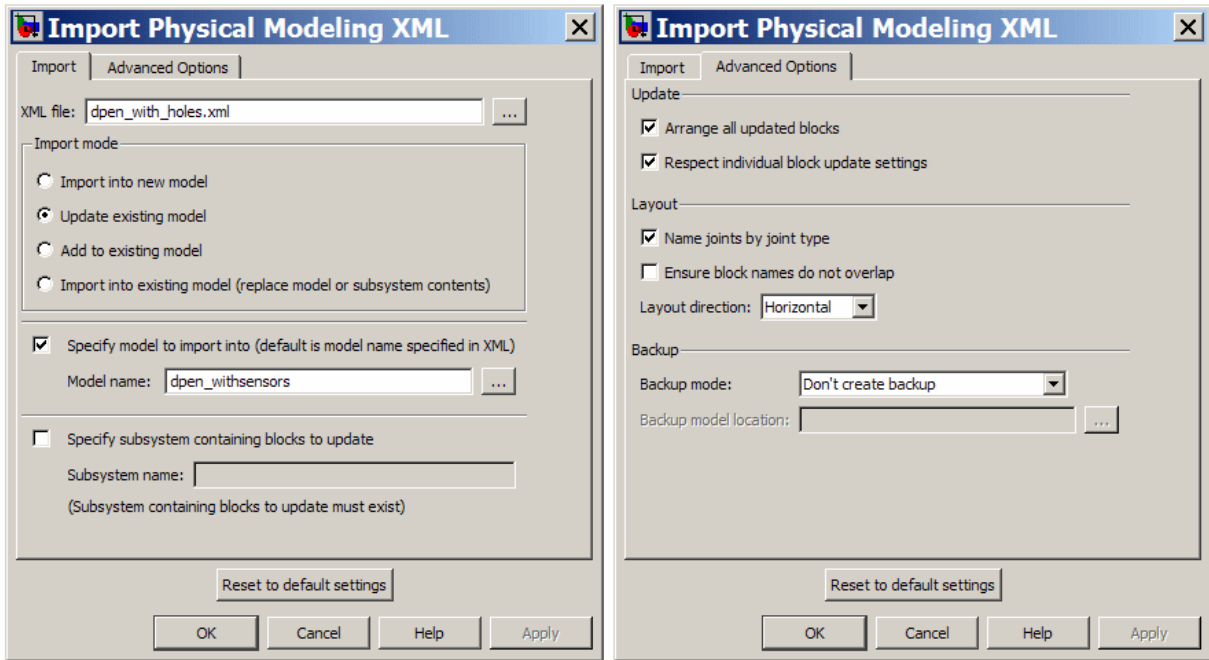

Alternatively, if you want to use the command with fully specified options, enter:

```
mech_import('dpen_with_holes', 'ImportMode', 1, ...
            'ModelToImportInto', 'dpen_withsensors', 'LayoutWithUpdate', 1, ...
            'EnableIndvBlkUpdCtrl', 1, 'BackupMode', 0)
```

The updated model looks like the following. The sensors and Scopes are retained.

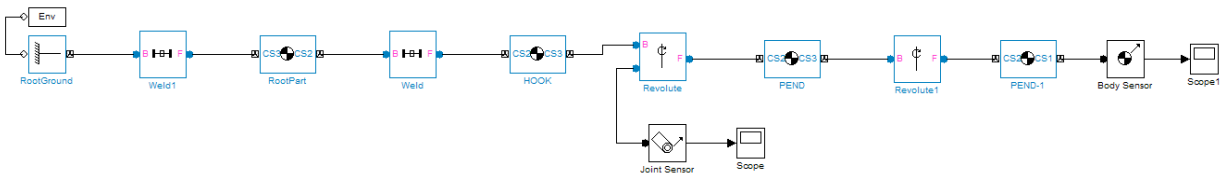

However, the PEND body properties are now different, because of the new holes in the parts. The PEND-1 mass properties are changed in the same way.

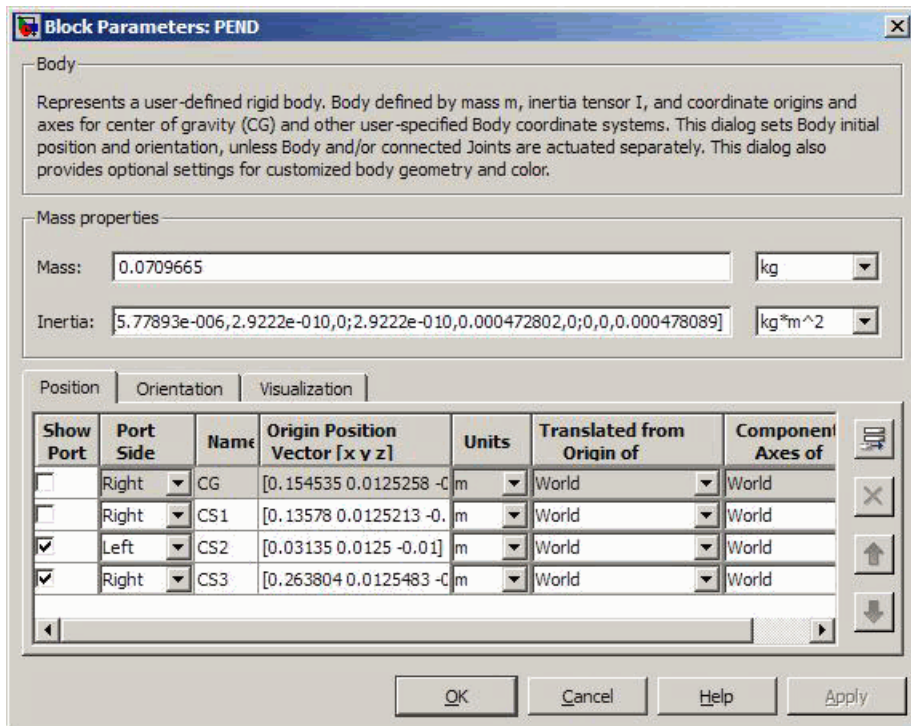

The updated bodies, displayed in SimMechanics visualization, appear differently as well, as determined by the new STL files exported from the updated assembly at the same time the new XML file was created.

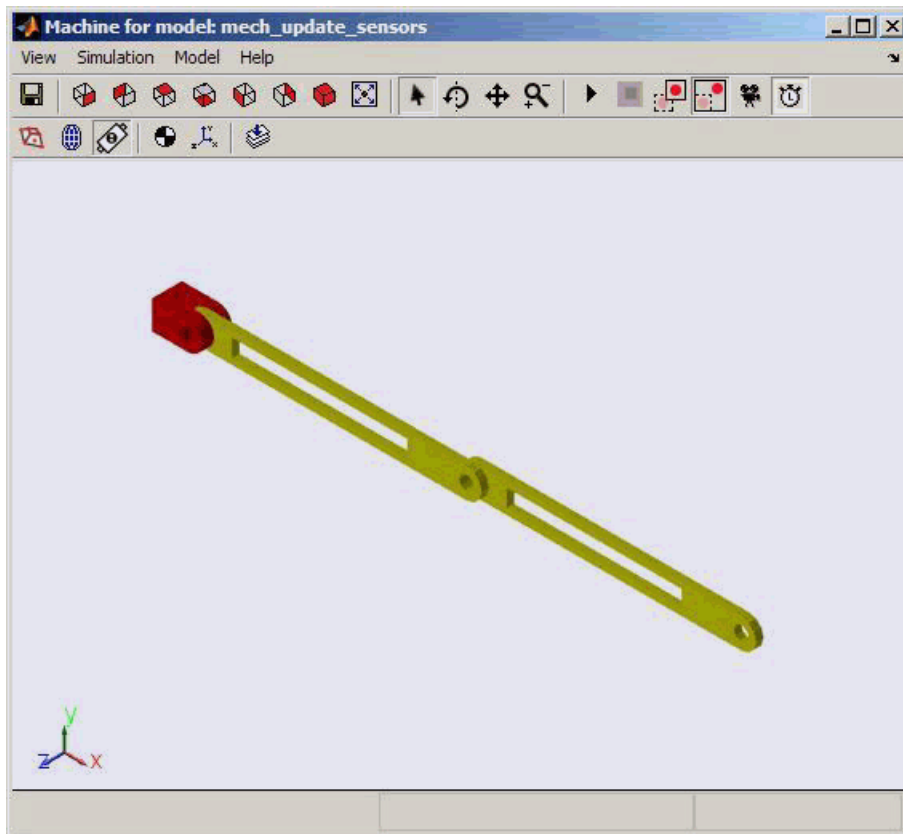

Add New Body to Create a Triple Pendulum

The changes to an assembly that you can re-export are not limited to changes in existing parts (bodies). You can add or remove parts, re-export, then update-import an older version of the generated model with the changes.

In this example, in addition to the holes in the parts you previously made, you change the original assembly further by adding a new part (link) between the two original pendulum links, making the assembly a triple pendulum. This addition changes the topology of the assembly (the assembly's connectivity), beyond the property changes to the individual links.

Modify and Update CAD Assembly

To see such a changed assembly, open the `tpen` assembly file. The `tpen` assembly is a copy of the `dpen` assembly with a link inserted. Export a new XML file, which is named `tpen.xml`.

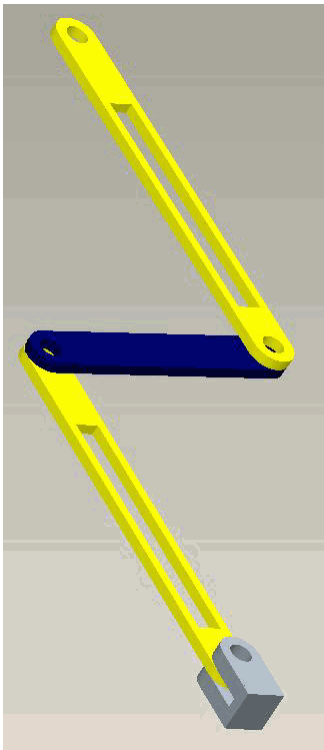

Updating the Existing Generated Model

Update the existing `dpen_withsensors` model with the changes to the assembly. These are the required options in the import dialog box.

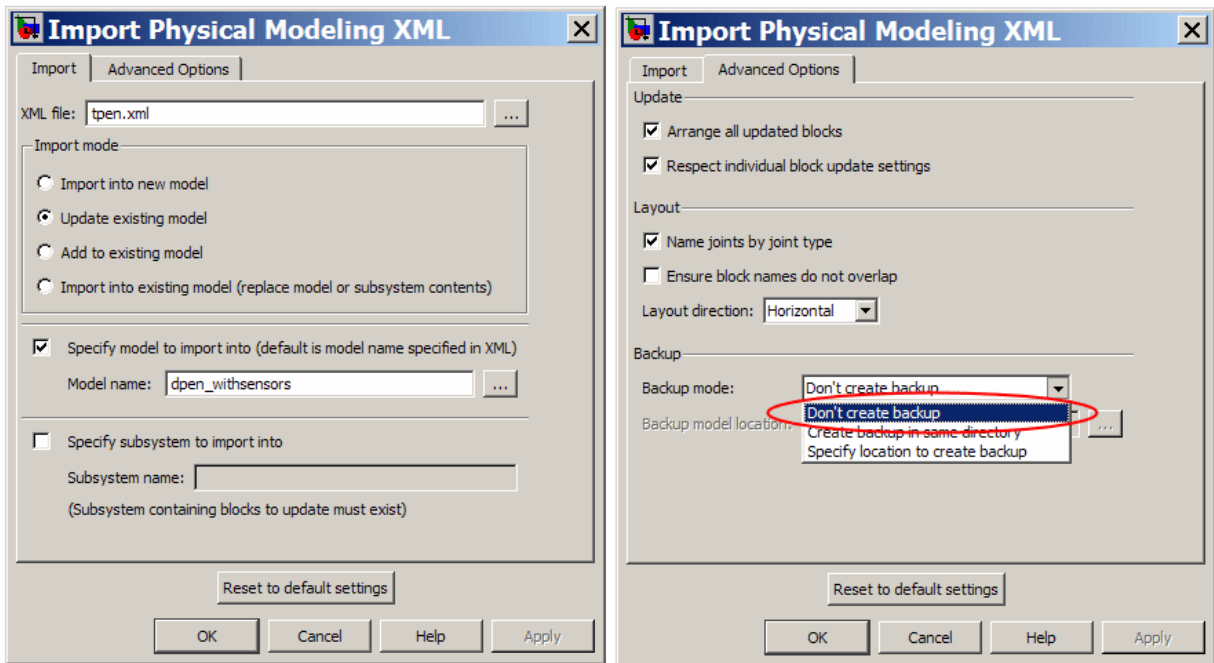

The **Advanced Options** tab shows important options selected for this example.

Advanced Option	Effect of Option
Arrange all updated blocks	Selecting this option causes the importer to rearrange all the imported and updated blocks. If cleared, the importer does not alter the layout of the existing blocks, whether updated or not, and places the newly imported blocks around the bounding box for the already existing blocks. In many cases, this means you have to rearrange the newly imported blocks by hand.
Respect individual block update settings	Selecting this option preserves the associativity information specified on each block.
Backup mode	Using this pull-down menu allows you to choose how the model is backed up during update. the backup options.

Advanced Option	Effect of Option
	By default, the backup copy of the model is created in the same folder as the model being updated.

The equivalent command line import command is:

```
mech_import('tpen.xml', 'ImportMode', 1, ...
            'ModelToImportInto', 'dpen_withsensors', 'LayoutWithUpdate', 1, ...
            'EnableIndvBlkUpdCtrl', 1, 'BackupMode', 0)
```

The block diagram shows that the part MID_PART inserted between the two links PEND and PEND-1. The sensors are retained. The properties of PEND and PEND-1 have been updated (to incorporate the holes that are now present). Because the **Arrange all updated blocks** option was selected, the blocks PEND and PEND-1 were moved to accommodate the block MID_PART and the joints Revolute2 and Revolute3.

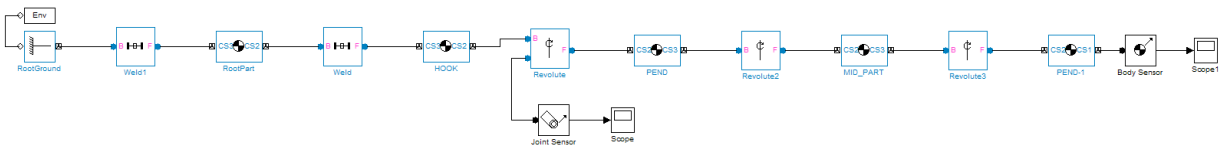

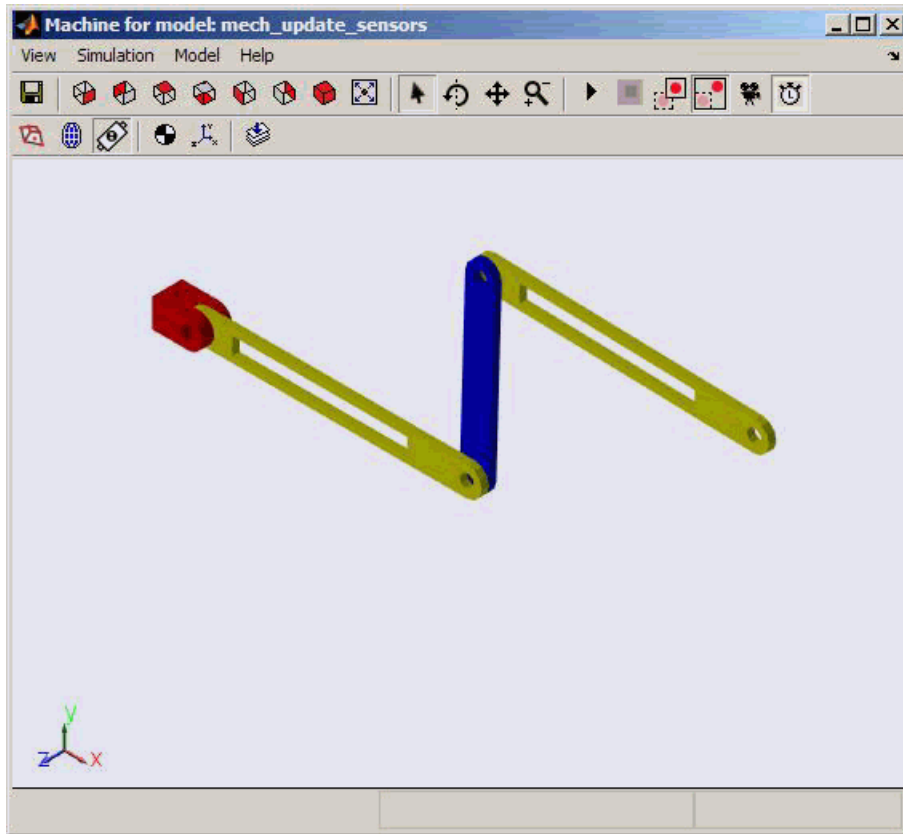

Disabling Automatic Block Arrangement

The following block diagram shows the updated model that results when the **Arrange all updated blocks** option is cleared. The importer places the newly imported blocks around the bounding box of the existing blocks. The layout of the existing blocks is unchanged.

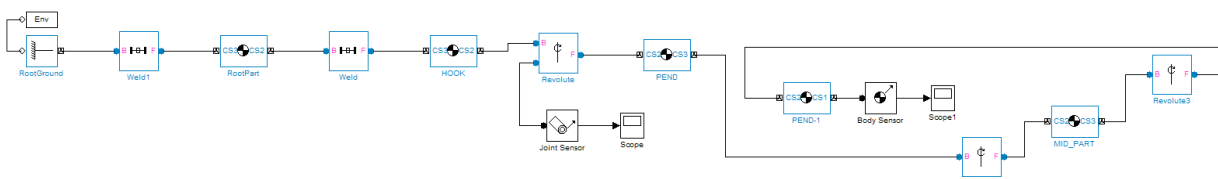

Update Imported Model While Retaining Manual Joint Replacements

Note: The modified double pendulum model, `dpen_jointrep`, with the replaced joint but prior to the assembly changes, is available as a SimMechanics example, `mech_update_jointreplacement`.

In circumstances where a set of assembly constraints imposes ambiguous restrictions on the motions of two parts, the SimMechanics Link exporter cannot resolve the constraint set into a moving joint. In such cases, it exports a Weld joint. If so, it is up to you to manually replace the Weld joint with the appropriate moving joint in the generated model. Even in situations where the exporter creates a moving joint, it might not reflect the degrees of freedom that you want, and you might want to replace it with another. When you have replaced such joints in an imported model, and you want to update the model with changes from the CAD assembly, you generally want to retain the replacements you made manually.

- 1 Create a `dpen_jointrep` model in the following way.

Open the `dpen_withsensors` model and replace the Revolute joint between the two link bodies by a Planar joint that has some compliance in the plane perpendicular to the original revolute axis. Rename the Planar joint to Revolute with Compliance.

- 2 To update this model with changes to the link body properties, but to still retain the new Planar joint, right-click the Revolute with Compliance block and select the **Retain connectivity to imported blocks** option. It is selected by default.

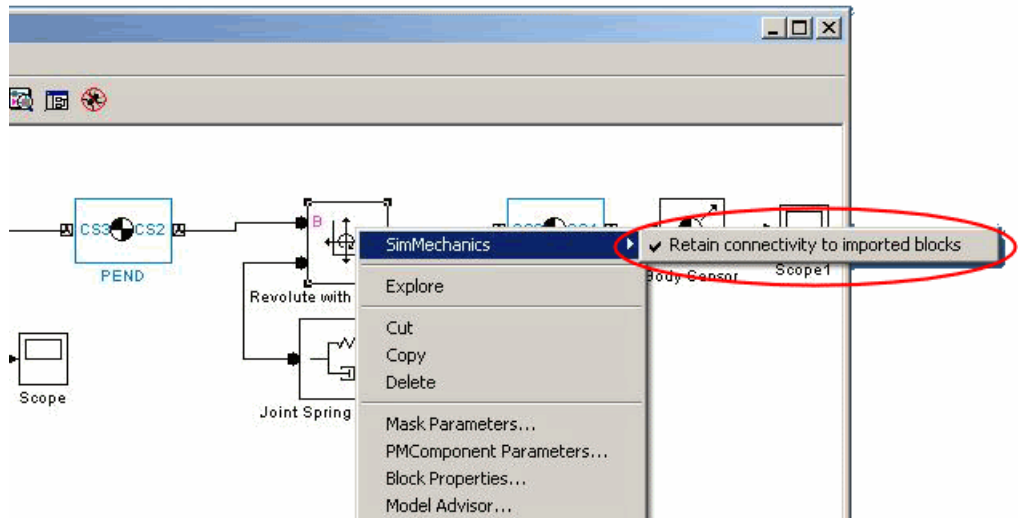

- 3 Update this model with the new XML file that has changes to the properties of the links.

```

mech_import('dpen.xml', 'ImportMode', 1, ...
            'ModelToImportInto', 'dpen_jointrep', 'LayoutWithUpdate', 1, ...
            'EnableIndv1BlkUpdCtrl', 1, 'BackupMode', 0)
    
```

The updated model retains the Revolute with Compliance joint.

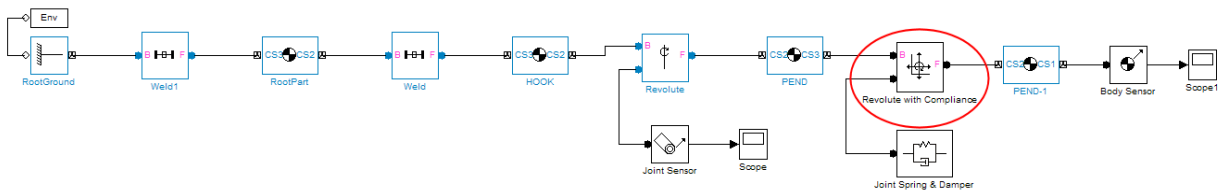

Selectively Update Imported Model

You can update certain bodies while not updating other bodies with changes. Prevent a particular body from being updated during reimport by:

- 1 Right-clicking the body and selecting the **Retain without updating properties** option under the **SimMechanics** submenu.

- 2 Selecting the **Respect individual block update settings** option in the import dialog box.

If you use the full command instead, you need to set the `EnableIndv1BlkUpdCtrl` option to true.

Clearing the **Respect individual block update settings** check box causes the importer to update all blocks, disregarding the update settings on the individual blocks.

Export CAD Robot Arm

In this section...

“CAD Robot Arm Files” on page 5-38

“CAD Robot Arm Properties” on page 5-38

“Export Robot Arm Assembly” on page 5-40

“Import Model” on page 5-40

CAD Robot Arm Files

The following example is based on a more complex CAD assembly, a robot arm. It includes multiple parts, two closed loops, multiple constraints, and a subassembly. Look for the 11 CAD files of this case study in the SimMechanics Link examples folder.

File Name	CAD File Type
robot.ASSEMBLYFILETYPE	Assembly
grip.ASSEMBLYFILETYPE	Subassembly (flexible)
base.PARTFILETYPE forearm.PARTFILETYPE upperarm.PARTFILETYPE wrist.PARTFILETYPE	Parts (main assembly)
fingertips.PARTFILETYPE (twice) firstfingerlink.PARTFILETYPE firstfingerlinkL.PARTFILETYPE metacarpal.PARTFILETYPE secondfingerlink.PARTFILETYPE (twice)	Parts (subassembly)

CAD Robot Arm Properties

Open the assembly file for the whole robot.

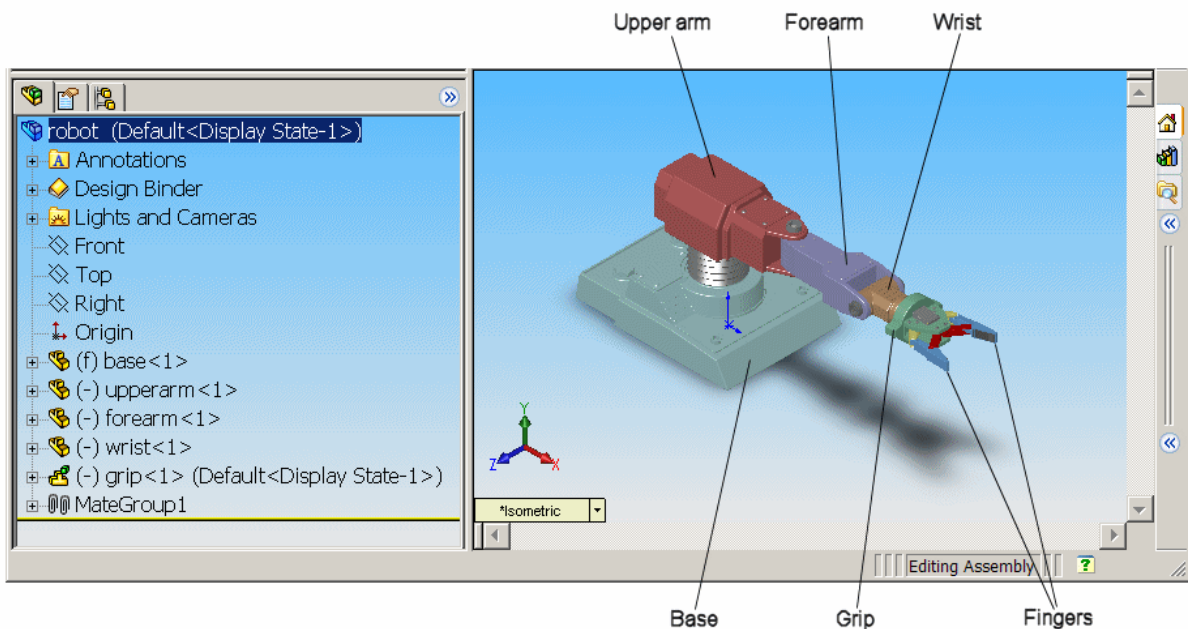

Robot Arm Assembly in a CAD Platform

In the assembly tree to the left of the window, examine the CAD hierarchy:

- Five of the part files are grouped into the subassembly **grip**. The subassembly uses two instances each of **fingertips** and **secondfingerlink**.
- The subassembly has its own group of 18 constraints, **MateGroup1**.

Two constraints, **Angle1** and **Angle2**, are not active. If they were, they would lock the grip fingers into the open position. Here, each grip finger can move separately.

- The other four part files are separate and grouped into the main assembly.
- The main assembly has its own **MateGroup1**, consisting of seven constraints.

The whole assembly has eight DoFs. The **grip** subassembly alone contains two, allowing each finger to open and close separately. The main assembly has six DoFs:

- The upper arm can move relative to the base by pitching, yawing, and rolling (three DoFs).
- The forearm can yaw relative to the upper arm (one DoF).

- The wrist can pitch relative to the forearm (one DoF).
- The grip can rotate about its symmetry axis (one DoF).

Export Robot Arm Assembly

Apply any changes you want to the assembly configuration or settings. If you change the assembly or any subassemblies, you need to rebuild the assembly before exporting it to XML.

Using the SimMechanics Link interface to your CAD platform, export the assembly into Physical Modeling XML. The XML file `robot.xml` appears in your working CAD folder.

Import Model

Once you have exported the CAD assembly, you can generate the corresponding SimMechanics model. Using the `mech_import` command, you import the Physical Modeling XML file that SimMechanics Link generated during export, and let SimMechanics automatically generate the model for you. Then, review the model and make any required changes to the model. For a step-by-step description of the CAD Import procedure, see “Import Robot Arm Model”.

Export a CAD Stewart Platform

In this section...

“About the Stewart Platform” on page 5-41

“CAD Assembly” on page 5-41

“Open Assembly” on page 5-42

“Export Assembly” on page 5-43

“Import Model” on page 5-43

About the Stewart Platform

The Stewart platform consists of two plates connected by six mobile and extensible legs. The lower or base plate is immobile. The upper or mobile plate has six degrees of freedom, three rotational and three translational. The platform is a six-degree-of-freedom (DoF) mechanical system used for accurate positioning applications. It is highly stable and easy to control.

The platform's six legs each have two parts, an upper and a lower leg, with a piston-like cylindrical DoF between each pair of parts. The legs are connected to the base plate and the top plate by universal joints at each end of each leg. (These universals are not just sets of abstract DoFs. Each also contains a spider-like body, while also having two DoFs.) The upper part of each leg can slide into and out of the lower leg, allowing each leg to be varied in length. The position and orientation of the mobile platform (top plate) varies depending on the lengths to which the six legs are separately adjusted.

Once the top is connected to the legs, the entire Stewart platform assembly has 36 DoFs. Only six DoFs are *independent*, the same as the top plate would have if it were disconnected. You can think of these independent DoFs as the six adjustable leg lengths or as equivalent to the six DoFs of the mobile plate.

CAD Assembly

The following example uses a complex computer-aided design (CAD) assembly that models the Stewart platform.

Note The Stewart platform assembly in this example is an advanced example of computer-aided design. You should work through the previous case studies before attempting to work with this assembly.

Stewart Platform Assembly Files

Look for the 45 CAD files of this case study in the *smlink/smlinkdemos* directory. The master assembly file is:

stewart_platform.ASSEMBLYFILETYPE

Open Assembly

Open the master assembly file, *stewart_platform.ASSEMBLYFILETYPE*. Click the assembly and rotate it to view the top and bottom plates and the legs.

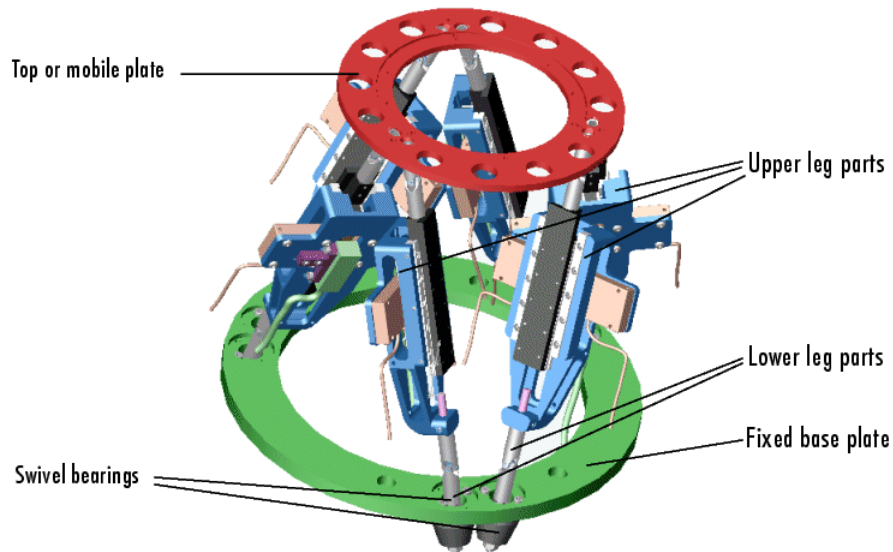

Stewart Platform CAD Assembly

The CAD hierarchy for the Stewart platform contains assemblies for the top and base plates, as well as assemblies for the six legs. All the constraints on the assembly parts

are grouped into one group, containing 30 constraints. There are 448 component parts and 38 subassemblies, which you can open individually to examine the separate parts.

The base plate is about 24 centimeters (cm) in diameter; the top plate about 16.5 cm. When centered and oriented flat, the top plate is about 20 cm above the base. The assembly models the platform material as aluminum (about 2.7 grams per cubic cm).

Export Assembly

Apply any changes you want to the assembly configuration or settings. If you change the assembly or any subassemblies, you need to rebuild the assembly before exporting it to XML.

Using the SimMechanics Link interface to your CAD platform, export the assembly into Physical Modeling XML. Because the assembly is so complex, the export process takes longer than it does for simpler assemblies. As the export proceeds, various parts and subassemblies are highlighted. When the highlighting stops, the export is finished.

The exported model appears as `stewart_platform.xml` in your working CAD folder.

Import Model

Once you have exported the CAD assembly, you can generate the corresponding SimMechanics model. Using the `mech_import` command, you import the Physical Modeling XML file that SimMechanics Link generated during export, and let SimMechanics automatically generate the model for you. Then, review the model and make any required changes to the model. For a step-by-step description of the CAD Import procedure, see “Import a CAD Stewart Platform Model”.

